



**Technical and Test Institute
for Construction Prague**

Prosecká 811/76a
190 00 Prague
Czech Republic
eota@tzus.cz



Member of



www.eota.eu

European Technical Assessment

**ETA 17/0720
of 28/08/2017**

(English language translation, the original version in Czech language)

Technical Assessment Body issuing the ETA: Technical and Test Institute
for Construction Prague

Trade name of the construction product

ResiFIX PYSF
ResiFIX PYSF Change
ResiFIX PYSF Express
ResiFIX PYSF Tropical

**Product family to which the
construction product belongs**

Product area code: 33
Injection anchors for use in masonry

Manufacturer

Apolo MEA Befestigungssysteme GmbH
Industriestr. 6
86551 Aichach
Germany

Manufacturing plant(s)

Plant 2, Germany

**This European Technical Assessment
contains**

56 pages including 52 Annexes which form
an integral part of this assessment.

**This European Technical Assessment is
issued in accordance with regulation
(EU) No 305/2011, on the basis of**

ETAG 029, edition 2013, used as European
Assessment Document (EAD)

Translations of this European Technical Assessment in other languages shall fully correspond to the original issued document and should be identified as such.

Communication of this European Technical Assessment, including transmission by electronic means, shall be in full (excepted the confidential Annex(es) referred to above). However, partial reproduction may be made, with the written consent of the issuing Technical Assessment Body. Any partial reproduction has to be identified as such.

1. Technical description of the product

The ResiFIX PYSF, ResiFIX PYSF Change, ResiFIX PYSF Express, ResiFIX PYSF Tropical polyester resin styrene-free for masonry is bonded anchor consisting of a cartridge with injection mortar, a steel element and a plastic sleeve. The steel elements are the commercial threaded rods with hexagon nut and washer. The steel elements are made of galvanized or zinc plated steel, stainless or high corrosion resistance steel. The anchor is placed into a drilled hole filled with injection mortar. The steel element is anchored via the bond between metal part, injection mortar and masonry.

The illustration and the description of the product are given in Annex A.

2. Specification of the intended use in accordance with the applicable EAD

The performances given in Section 3 are only valid if the anchor is used in compliance with the specifications and conditions given in Annex B.

The provisions made in this European Technical Assessment are based on an assumed working life of the anchor of 50 years. The indications given on the working life cannot be interpreted as a guarantee given by the producer, but are to be regarded only as a means for choosing the products in relation to the expected economically reasonable working life of the works.

3. Performance of the product and references to the methods used for its assessment

3.1 Mechanical resistance and stability (BWR 1)

Essential characteristic	Performance
Reduction factor for job site tests (β – factor)	See Annex C 1
Characteristic resistance for tension and shear loads	See Annex C 5 to C 39
Characteristic resistance for bending moments	See Annex C 2
Displacement under shear and tension loads	See Annex C 5 to C 38
Edge distances and spacing	See Annex C 4 to C 38

3.2 Safety in case of fire (BWR 2)

Essential characteristic	Performance
Reaction to fire	Anchorage satisfy requirements for Class A1
Resistance to fire	No performance assessed

3.3 Hygiene, health and environment (BWR 3)

Regarding dangerous substances contained in this European Technical Assessment, there may be requirements applicable to the products falling within its scope (e.g. transposed European legislation and national laws, regulations and administrative provisions). In order to meet the provisions of the Regulation (EU) No 305/2011), these requirements need also to be complied with, when and where they apply.

3.4 Safety in use (BWR 4)

For basic requirement safety in use the same criteria are valid as for Basic Requirement Mechanical resistance and stability.

3.5 Sustainable use of natural resources (BWR 7)

For the sustainable use of natural resources no performance was determined for this product.

3.6 General aspects relating to fitness for use

Durability and serviceability are only ensured if the specifications of intended use according to Annex B 1 are taken into account.

4. Assessment and verification of constancy of performance (AVCP) system applied with reference to its legal base

According to the Decision 97/177/EC of the European Commission¹ the system of assessment verification of constancy of performance (see Annex V to Regulation (EU) No 305/2011) given in the following table applies.

Product	Intended use	Level or class	System
Injection anchors for use in masonry	For fixing and/or supporting to masonry, structural elements (which contributes to the stability of the construction works) or heavy units	-	1

5. Technical details necessary for the implementation of the AVCP system, as provided in the applicable EAD

5.1 Tasks of the manufacturer

The manufacturer shall exercise permanent internal control of production. All the elements, requirements and provisions adopted by the manufacturer shall be documented in a systematic manner in the form of written policies and procedures, including records of results performed. This production control system shall insure that the product is in conformity with this European Technical Assessment.

The manufacturer may only use raw materials stated in the technical documentation of this European Technical Assessment.

The factory production control shall be in accordance with the control plan which is a part of the technical documentation of this European Technical Assessment. The control plan is laid down in the context of the factory production control system operated by the manufacturer and deposited at Technical and Test Institute for Construction Prague² The results of factory production control shall be recorded and evaluated in accordance with the provisions of the control plan.

The manufacturer shall, on the basis of a contract, involve a body which is notified for the tasks referred to in section 4 in the field of anchors in order to undertake the actions laid down in section 5.2. For this purpose, the control plan referred to in this section and section 5.2 shall be handed over by the manufacturer to the notified body involved.

The manufacturer shall make a declaration of conformity, stating that the construction product is in conformity with the provisions of this European Technical Assessment.

¹ Official Journal of the European Communities L 073 of 14.03.1997

² The control plan is a confidential part of the documentation of the European technical assessment, but not published together with the ETA and only handed over to the approved body involved in the procedure of AVCP.

5.2 Tasks of the notified bodies

The notified body shall retain the essential points of its actions referred to above and state the results obtained and conclusions drawn in a written report.

The notified certification body involved by the manufacturer shall issue a certificate of constancy of performance of the product stating the conformity with the provisions of this European Technical Assessment.

In cases where the provisions of the European Technical Assessment and its control plan are no longer fulfilled the notified body shall withdraw the certificate of constancy of performance and inform Technical and Test Institute for Construction Prague without delay.

Issued in Prague on 28.08.2017

By

Ing. Mária Schaan
Head of the TAB

Installation in hollow brick; threaded rod with sleeve

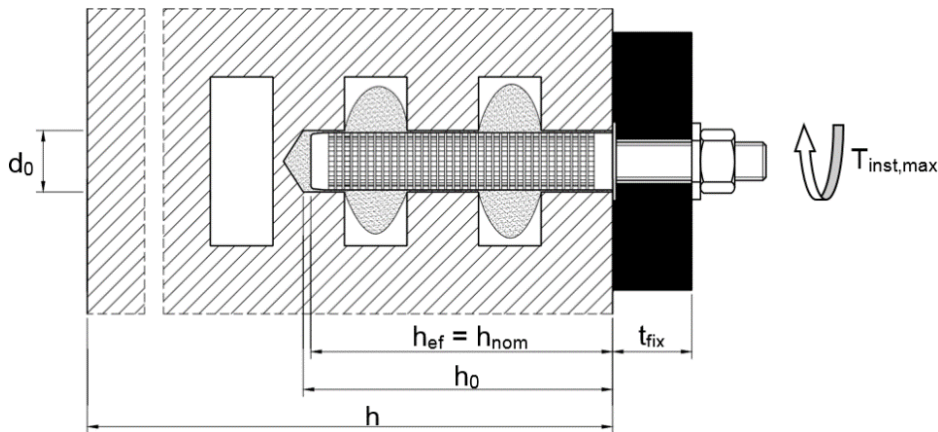

Installation in solid brick; threaded rod with sleeve

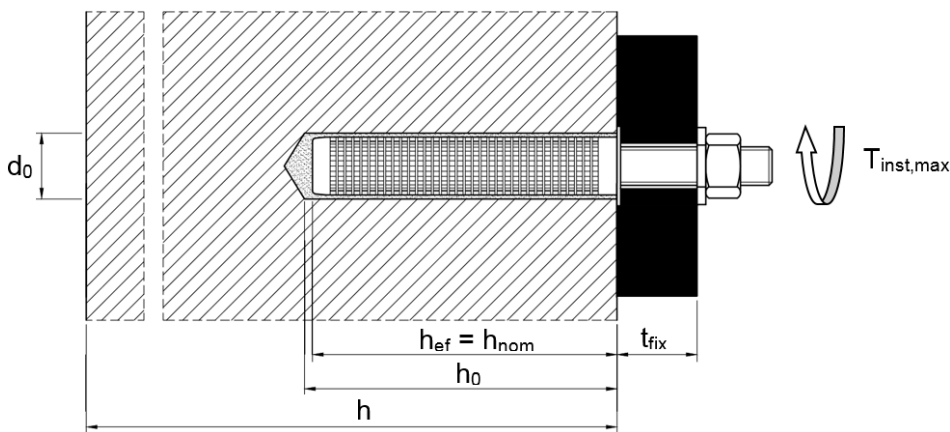

Installation in solid brick; threaded rod without sleeve

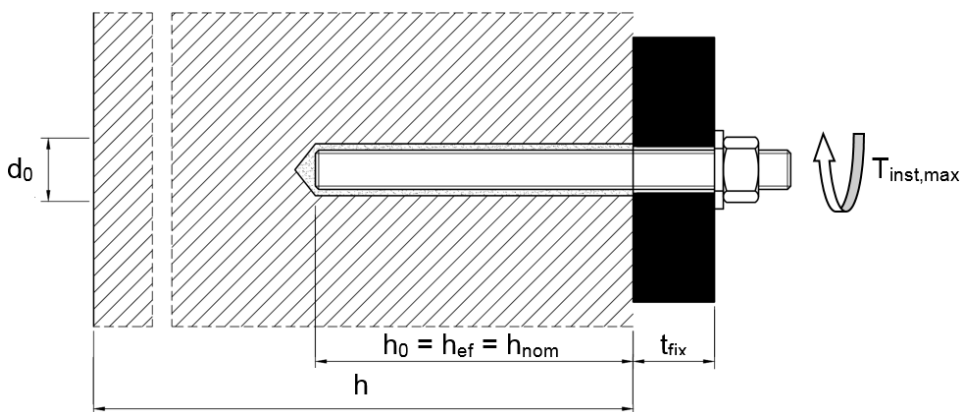

d_0 = nominal drill hole diameter
 t_{fix} = thickness of fixture
 $T_{inst,max}$ = max installation torque moment

h = thickness of member
 h_0 = depth of drill hole at shoulder
 h_{ef} = effective anchorage depth
 h_{nom} = overall embedment depth

Apolo MEA Injection System for masonry
ResiFIX PYSF, PYSF Change, PYSF Express, PYSF Tropical

Product description
 Installed condition

Annex A 1

Cartridge: ResiFIX PYSF, ResiFIX PYSF Change, ResiFIX PYSF Express, ResiFIX PYSF Tropical

150 ml, 280 ml, 300 ml up to 333 ml, 380 ml up to 420 ml cartridge (Type: coaxial)

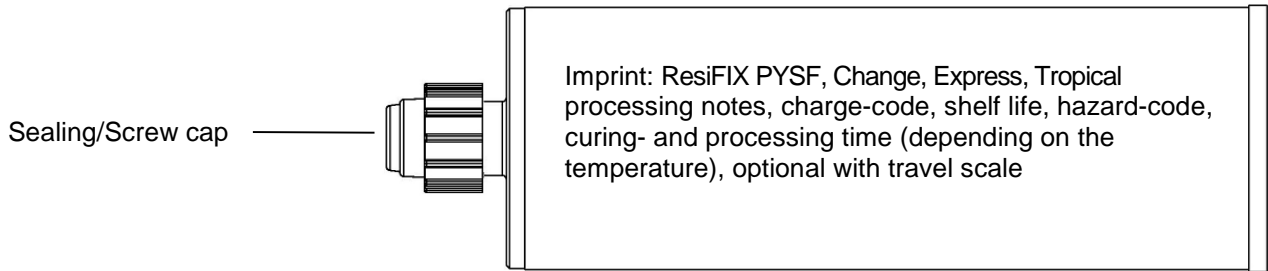

235 ml, 345 ml up to 360 ml, 825 ml cartridge (Type: “side-by-side”)

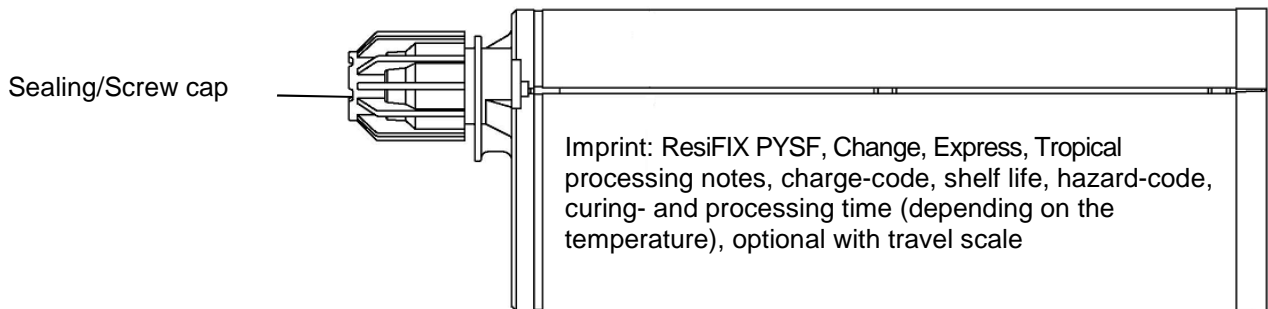

165 ml and 300 ml cartridge (Type: “foil tube”)

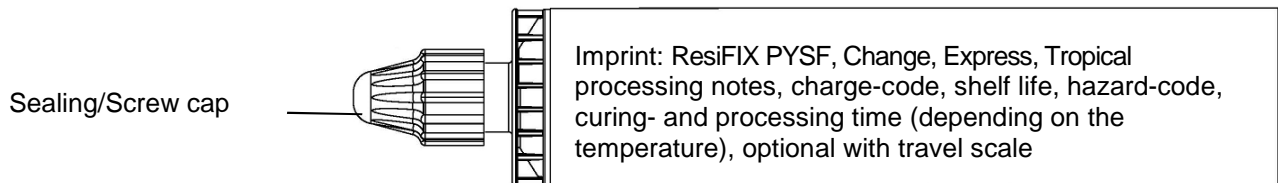

Static mixer

SM 14W



or

CM 8W



**Apolo MEA Injection System for masonry
ResiFIX PYSF, PYSF Change, PYSF Express, PYSF Tropical**

Product description
Injection system

Annex A 2

Threaded rod M8 / M10 / M12 / M16

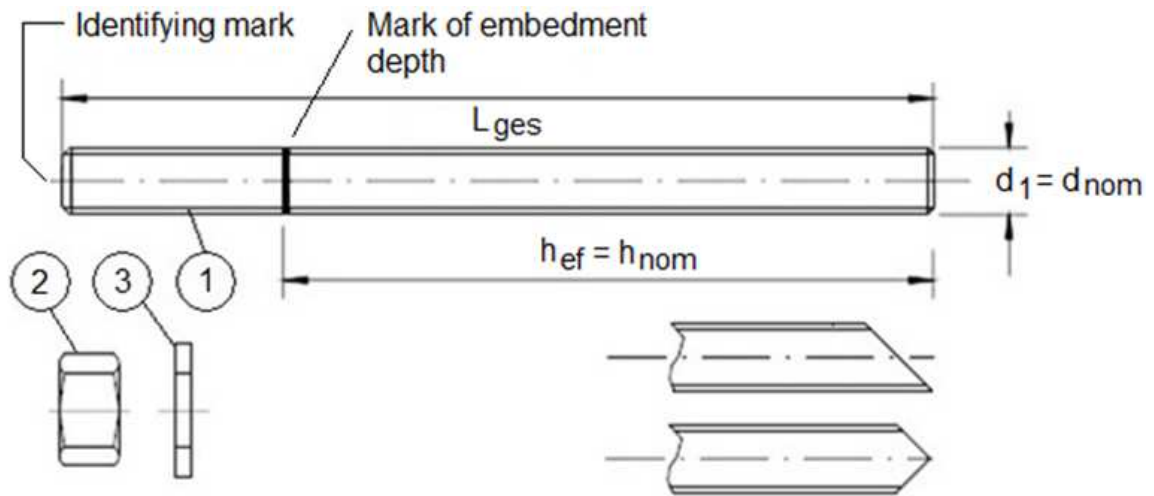

Commercial standard threaded rod with:

- Materials, dimensions and mechanical properties acc. Table A1
- Inspection certificate 3.1 acc. to EN 10204:2004. The document shall be stored.
- Marking of embedment depth

Apolo MEA Injection System for masonry
ResiFIX PYSF, PYSF Change, PYSF Express, PYSF Tropical

Product description
 Threaded rod

Annex A 3

Table A1: Materials

Part	Designation	Material
Steel, zinc plated $\geq 5 \mu\text{m}$ acc. to EN ISO 4042:2001 or Steel, hot-dip galvanised $\geq 40 \mu\text{m}$ acc. to EN ISO 1461:2009 and EN ISO 10684:2011+AC:2009		
1	Anchor rod	Steel, EN 10087:1998 or EN 10263:2001 Strength class 4.6, 4.8, 5.6, 5.8, 8.8 EN 1993-1-8:2005+AC:2009
2	Hexagon nut, EN ISO 4032:2012	Steel acc. to EN 10087:1998 or EN 10263:2001 Strength class 4 (for class 4.6, 4.8 rod) EN ISO 898-2:2012 Strength class 5 (for class 5.6, 5.8 rod) EN ISO 898-2:2012 Strength class 8 (for class 8.8 rod) EN ISO 898-2:2012
3	Washer, EN ISO 887:2006, EN ISO 7089:2000, EN ISO 7093:2000, or EN ISO 7094:2000	Steel, zinc plated or hot-dip galvanised
Stainless steel		
1	Anchor rod	Material 1.4401 / 1.4404 / 1.4571, EN 10088-1:2014, Strength class 70 EN ISO 3506-1:2009 Strength class 80 EN ISO 3506-1:2009
2	Hexagon nut, EN ISO 4032:2012	Material 1.4401 / 1.4404 / 1.4571 EN 10088-1:2014, Strength class 70 (for class 70 rod) EN ISO 3506-2:2009 Strength class 80 (for class 80 rod) EN ISO 3506-2:2009
3	Washer, EN ISO 887:2006, EN ISO 7089:2000, EN ISO 7093:2000, or EN ISO 7094:2000	Material 1.4401, 1.4404 or 1.4571, EN 10088-1:2014
High corrosion resistant steel (HCR)		
1	Anchor rod	Material 1.4529 / 1.4565, EN 10088-1:2014, Strength class 70 EN ISO 3506-1:2009 Strength class 80 EN ISO 3506-1:2009
2	Hexagon nut, EN ISO 4032:2012	Material 1.4529 / 1.4565 EN 10088-1:2014, Strength class 70 (for class 70 rod) EN ISO 3506-2:2009 Strength class 80 (for class 80 rod) EN ISO 3506-2:2009
3	Washer, EN ISO 887:2006, EN ISO 7089:2000, EN ISO 7093:2000 or EN ISO 7094:2000	Material 1.4529 / 1.4565, EN 10088-1:2014

**Apolo MEA Injection System for masonry
ResiFIX PYSF, PYSF Change, PYSF Express, PYSF Tropical**

Product description
Materials

Annex A 4

Sleeve (Plastic)

SH 12x80
SH 16x85
SH 20x85

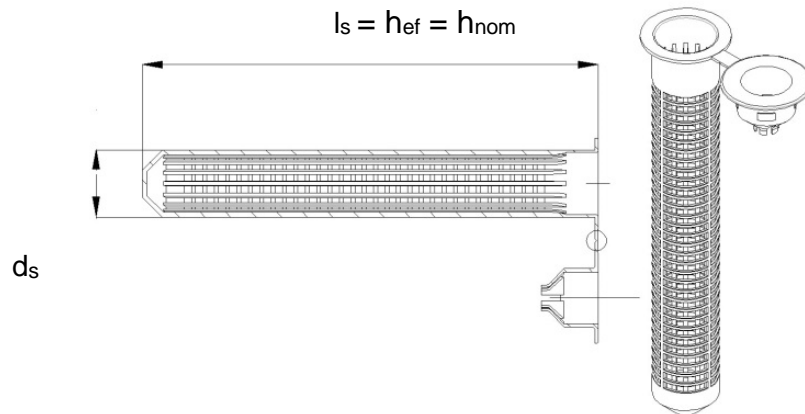

SH 16x130
SH 20x130
SH 20x200

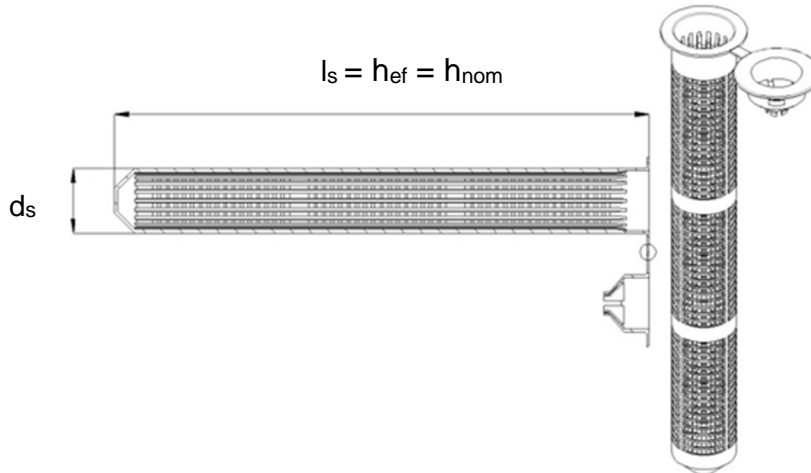

SH 16x130/330

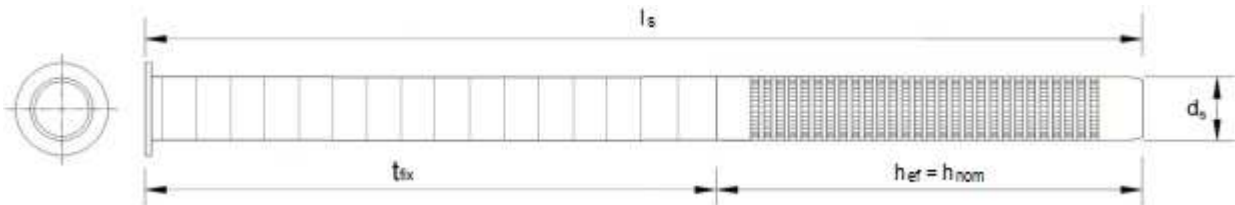

Table A2: Sleeve sizes (mm)

Size	Sleeve		
	d_s [mm]	l_s [mm]	$h_{ef} = h_{nom}$ [mm]
SH12x80	12	80	80
SH16x85	16	85	85
SH16x130	16	130	130
SH16x130/330	16	330	130
SH20x85	20	85	85
SH20x130	20	130	130
SH20x200	20	200	200

**Apolo MEA Injection System for masonry
ResiFIX PYSF, PYSF Change, PYSF Express, PYSF Tropical**

Product description
Sleeves

Annex A 5

Specifications of intended use

Anchorage subject to:

- Static and quasi-static loads

Base materials

- Autoclaved Aerated Concrete (Use category d) to Annex B2.
- Solid brick masonry (Use category b), according to Annex B2 to B4.
- Hollow brick masonry (Use category c), according to Annex B2 to B4.
- Mortar strength class of the masonry M2,5 at minimum according to EN 998-2:2010.
- Joints of the masonry must be visible and filled with mortar.
- For other bricks in solid masonry and in hollow or perforated masonry, the characteristic resistance of the anchor may be determined by job site tests according to ETAG 029, Annex B under consideration of the β -factor to Annex C1, Table C1.

Note: The characteristic resistances are also valid for larger brick sizes and larger compressive strength of the masonry unit.

Temperature range:

- T_a : -40°C to +40°C (max. short. term temperature +40°C and max. long term temperature +24°C)
- T_b : -40°C to +80°C (max. short. term temperature +80°C and max. long term temperature +50°C)

Use conditions (Environmental conditions)

- Dry and wet structures (regarding injection mortar).
- Structures subject to dry internal conditions (zinc coated steel, stainless steel or high corrosion resistant steel).
- Structures subject to external atmospheric exposure (including industrial and marine environment) and to permanently damp internal condition, if no particular aggressive conditions exist (stainless steel or high corrosion resistant steel).
- Structures subject to external atmospheric exposure and to permanently damp internal condition, if other particular aggressive conditions exist (high corrosion resistant steel).

Note: Particular aggressive conditions are e.g. permanent, alternating immersion in seawater or the splash zone of seawater, chloride atmosphere of indoor swimming pools or atmosphere with extreme chemical pollution (e.g. in desulphurization plants or road tunnels where de-icing materials are used).

Use categories in respect of installation and use:

- Category d/d: Installation and use in dry masonry
- Category w/w: Installation and use in wet masonry (incl. w/d installation in wet masonry and use in dry masonry)

Design:

- Verifiable calculation notes and drawings are prepared taking account the relevant masonry in the region of the anchorage, the loads to be transmitted and their transmission to the supports of the structure. The position of the anchor is indicated on the design drawings.
- The anchorage are designed in accordance with the ETAG 029, Annex C, Design method A under the responsibility of an engineer experienced in anchorages and masonry work.

Installation:

- Dry or wet structures
- Anchor Installation carried out by appropriately qualified personnel and under the supervision of the person responsible for technical matters of the site.

**Apolo MEA Injection System for masonry
ResiFIX PYSF, PYSF Change, PYSF Express, PYSF Tropical**

**Intended use
Specifications**

Annex B 1

Table B1: Overview brick types and properties with corresponding fastening elements (Anchors and Sleeves)











Brick-Nr.	Brick type	picture	Brick size Length x width x height	Compressive strength	Bulk density	Sleeve - Anchor type	Annex
			[mm]	[N/mm ²]	[kg/dm ³]		
Autoclaved aerated concrete units according EN 771-4							
1	Autoclaved Aerated Concrete AAC2		599 x 375 x 249	2	0,35	M8 / M10 / M12 / M16	C4 / C5
2	Autoclaved Aerated Concrete AAC4		499 x 375 x 249	4	0,5	M8 / M10 / M12 / M16	C6 / C7
3	Autoclaved Aerated Concrete AAC6		499 x 240 x 249	6	0,6	M8 / M10 / M12 / M16	C8 / C9
Calcium silicate masonry units according EN 771-2							
4	Calcium silicate solid brick KS-NF		240 x 115 x 71	10 20 27	2,0	M8 / M10 / M12 / M16 SH 12x80 – M8 SH 16x85 – M8 / M10 SH 16x130 – M8 / M10 SH 16x130/330 - M8 / M10 SH 20x85 – M12 / M16 SH 20x130 – M12 / M16 SH 20x200 – M12 / M16	C10 / C11
5	Calcium silicate hollow brick KS L-3DF		240 x 175 x 113	8 12 14	1,4	SH 12x80 – M8 SH 16x85 – M8 / M10 SH 16x130 – M8 / M10 SH 16x130/330 - M8 / M10 SH 20x85 – M12 / M16 SH 20x130 – M12 / M16 SH 20x200 – M12 / M16	C12 / C13
6	Calcium silicate hollow brick KS L-12DF		498 x 175 x 238	10 12 16	1,4	SH 12x80 – M8 SH 16x85 – M8 / M10 SH 16x130 – M8 / M10 SH 16x130/330 - M8 / M10 SH 20x130 – M12 / M16	C14 / C15
Apolo MEA Injection System for masonry ResiFIX PYSF, PYSF Change, PYSF Express, PYSF Tropical						Annex B 2	
Intended use Brick types and properties with corresponding fastening elements							

Table B1: Overview brick types and properties with corresponding fastening elements (Anchors and Sleeves)

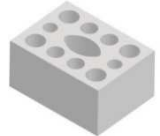

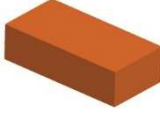
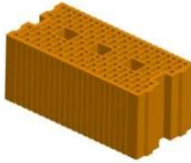



Brick-Nr.	Brick type	picture	Brick size Length x width x height	Compressive strength	Bulk density	Sleeve - Anchor type	Annex
			[mm]	[N/mm ²]	[kg/dm ³]		
Clay masonry units according EN 771-1							
7	Clay solid brick Mz – DF		240 x 115 x 55	10 20 28	1,64	M8 / M10 / M12 / M16 SH 12x80 – M8 SH 16x85 – M8 / M10 SH 16x130 – M8 / M10 SH 16x130/330 - M8 / M10 SH 20x85 – M12 / M16 SH 20x130 – M12 / M16 SH 20x200 – M12 / M16	C16 / C17
8	Clay hollow brick HLz-16DF		497 x 240 x 238	6 9 12 14	0,83	SH 12x80 – M8 SH 16x85 – M8 / M10 SH 16x130 – M8 / M10 SH 16x130/330 - M8 / M10 SH 20x85 – M12 / M16 SH 20x130 – M12 / M16 SH 20x200 – M12 / M16	C18 / C19
9	Clay hollow brick Porotherm Homebric		500 x 200 x 299	6 8 10	0,68	SH 12x80 – M8 SH 16x85 – M8 / M10 SH 16x130 – M8 / M10 SH 16x130/330 - M8 / M10 SH 20x85 – M12 / M16 SH 20x130 – M12 / M16	C20 / C21
10	Clay hollow brick BGV Thermo		500 x 200 x 314	4 6 10	0,62	SH 12x80 – M8 SH 16x85 – M8 / M10 SH 16x130 – M8 / M10 SH 16x130/330 - M8 / M10 SH 20x85 – M12 / M16 SH 20x130 – M12 / M16	C22 / C23
11	Clay hollow brick Calibric Th		500 x 200 x 314	6 9 12	0,62	SH 12x80 – M8 SH 16x85 – M8 / M10 SH 16x130 – M8 / M10 SH 16x130/330 - M8 / M10 SH 20x85 – M12 / M16 SH 20x130 – M12 / M16	C24 / C25
12	Clay hollow brick Urbanbric		560 x 200 x 274	6 9	0,74	SH 12x80 – M8 SH 16x85 – M8 / M10 SH 16x130 – M8 / M10 SH 16x130/330 - M8 / M10 SH 20x85 – M12 / M16 SH 20x130 – M12 / M16	C26 / C27

**Apolo MEA Injection System for masonry
ResiFIX PYSF, PYSF Change, PYSF Express, PYSF Tropical**

Intended use
Brick types and properties with corresponding fastening elements

Annex B 3

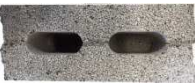
Table B1: Overview brick types and properties with corresponding fastening elements (Anchors and Sleeves)

Brick-Nr.	Brick type	picture	Brick size Length x width x height	Compressive strength	Bulk density	Sleeve - Anchor type	Annex
			[mm]	[N/mm ²]	[kg/dm ³]		
Clay masonry units according EN 771-1							
13	Clay hollow brick Blocchi Leggeri		250 x 120 x 250	4 6 8	0,55	SH 12x80 – M8 SH 16x85 – M8 / M10 SH 16x130 – M8 / M10 SH 16x130/330 - M8 / M10 SH 20x85 – M12 / M16 SH 20x130 – M12 / M16 SH 20x200 – M12 / M16	C28 / C29
14	Clay hollow brick Doppio Uni		250 x 120 x 120	10 16 20 28	0,92	SH 12x80 – M8 SH 16x85 – M8 / M10 SH 16x130 – M8 / M10 SH 16x130/330 - M8 / M10 SH 20x85 – M12 / M16 SH 20x130 – M12 / M16 SH 20x200 – M12 / M16	C30 / C31
Light weight concrete according EN 771-3							
15	Hollow light weight concrete Bloc creux B40		494 x 200 x 190	4	0,80	SH 12x80 – M8 SH 16x85 – M8 / M10 SH 16x130 – M8 / M10 SH 16x130/330 - M8 / M10 SH 20x85 – M12 / M16 SH 20x130 – M12 / M16	C32 / C33
16	Solid light weight concrete		300 x 123 x 248	2	0,63	M8 / M10 / M12 / M16	C34 / C35
17	Hollow light weight Leca Lex harkko RUH- 200		498 x 200 x 195	2,7	0,62	SH 12x80 – M8 SH 16x85 – M8 / M10 SH 16x130 – M8 / M10 SH 16x130/330 - M8 / M10 SH 20x85 – M12 / M16 SH 20x130 – M12 / M16	C36 / C37
18	Solid light weight Leca Lex RUH-200 Kulma		498 x 200 x 195	3	0,62	M8 / M10 / M12 / M16 SH 12x80 – M8 SH 16x85 – M8 / M10 SH 16x130 – M8 / M10 SH 16x130/330 - M8 / M10 SH 20x85 – M12 / M16 SH 20x130 – M12 / M16	C38 / C39
Apolo MEA Injection System for masonry ResiFIX PYSF, PYSF Change, PYSF Express, PYSF Tropical						Annex B 4	
Intended use Brick types and properties with corresponding fastening elements							

Installation: Steel brush



Table B2: Installation parameters in Autoclaved Aerated Concrete AAC and solid masonry (without sleeve)

Threaded rod			M8	M10	M12	M16
Nominal drill hole diameter	d_0	[mm]	10	12	14	18
Drill hole depth	h_0	[mm]	80	90	100	100
Effective anchorage depth	$h_{ef} = h_{nom}$	[mm]	80	90	100	100
Minimum wall thickness	h_{min}	[mm]	$h_{ef} + 30$			
Diameter of clearance hole in the fixture	$d_f \leq$	[mm]	9	12	14	18
Diameter of Steel brush	$d_b \geq$	[mm]	12	14	16	20
Max torque moment	$T_{inst,max}$	[Nm]	See parameters of brick Annex C4 to Annex C39			

Table B3: Installation parameters in solid and hollow masonry (with sleeve)

Threaded rod			M8	M8 / M10		M12 / M16			
Sleeve	[mm]		SH12x80	SH16x85	SH16x130	SH16x130/ 330	SH20x85	SH20x130	SH20x200
Nominal drill hole diameter	d_0	[mm]	12	16	16	16	20	20	20
Drill hole depth	h_0	[mm]	85	90	135	$135 + t_{fix}^{1)}$	90	135	205
Effective anchorage depth	$h_{ef} = h_{nom}$	[mm]	80	85	130	130	85	130	200
Minimum wall thickness	h_{min}	[mm]	115	115	195	195	115	195	240
Diameter of clearance hole in the fixture	$d_f \leq$	[mm]	9	9 (M8) / 12 (M10)		14 (M12) / 18 (M16)			
Diameter of brush	$d_b \geq$	[mm]	14	18		22			
Max torque moment	$T_{inst,max}$	[Nm]	See parameters of brick Annex C4 to Annex C39						

¹⁾ $t_{fix} < 200$ mm

**Apolo MEA Injection System for masonry
ResiFIX PYSF, PYSF Change, PYSF Express, PYSF Tropical**

Intended use
Installation parameters and cleaning brush

Annex B 5

Table B4: Maximum working time and minimum curing time

Temperature in the base material	ResiFIX PYSF Tropical		ResiFIX PYSF, PYSF Change ¹⁾		ResiFIX PYSF Express	
	Max. working time	Min. curing time	Max. working time	Min. curing time	Max. working time	Min. curing time
-10°C to -6°C					60 min	4 h
-5°C to -1°C			90 min	6 h	45 min	2 h
0°C to +4°C			45 min	3 h	25 min	80 min
+5°C to +9°C			25 min	2 h	10 min	45 min
+10°C to +14°C	30 min	5 h	20 min	100 min	4 min	25 min
+15°C to +19°C	20 min	210 min	15 min	80 min	3 min	20 min
+20°C to +29°C	15 min	145 min	6 min	45 min	2 min	15 min
+30°C to +34°C	10 min	80 min	4 min	25 min		
+35°C to +39°C	6 min	45 min	2 min	20 min		
+40°C to +44°C	4 min	25 min				
+45°C	2 min	20 min				
Cartridge temperature	+5°C to +45°C		+5°C to +40°C		-5°C to +30°C	

¹⁾ The PYSF Change injection mortar has a curing time proof by changing the color from blue to gray after curing minimum time. The curing time proof is only valid for the standard version of the mortar.

**Apolo MEA Injection System for masonry
ResiFIX PYSF, PYSF Change, PYSF Express, PYSF Tropical**

Intended use
Working and curing time

Annex B 6

Installation instructions

Preparation of cartridge

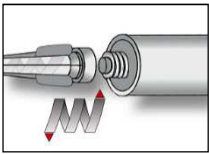

1. Remove the cap and attach the supplied static-mixing nozzle to the cartridge and load the cartridge into the correct dispensing tool. In case of a foil tube cartridge, cut off the clip before use. For every working interruption longer than the recommended working time (Table B4) as well as for new cartridges, a new static-mixer shall be used.

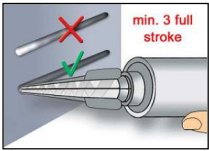

2. Prior to dispensing into the anchor hole, squeeze out separately a minimum of three full strokes, for foil tube cartridges six full strokes, and discard non-uniformly mixed adhesive components until the mortar shows a consistent grey or blue (PYSF Change) colour.

Installation in solid masonry (without sleeve)

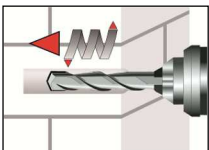

3. Holes to be drilled perpendicular to the surface of the base material by using a hard-metal tipped hammer drill bit. Drill a hole, with drill method according to Annex C4 – C39, into the base material, with nominal drill hole diameter and bore hole depth acc. to the size and embedment depth required by the selected anchor. In case of aborted drill hole the drill hole shall be filled with mortar.

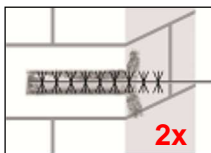
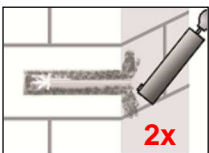

4. Blow out from the bottom of the drill hole two times. Attach the appropriate sized brush ($> d_{b,min}$ Table B2 or B3) to a drilling machine or a battery screwdriver, brush the hole clean two times, and finally blow out the hole again two times.

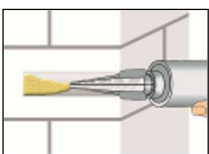

5. Starting from the bottom or back of the cleaned anchor hole fill the hole up to approximately two-thirds with adhesive. Slowly withdraw the static mixing nozzle as the hole fills to avoid creating air pockets. Observe the gel-/ working times given in Table B4.

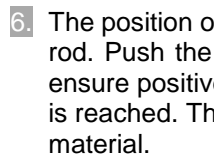
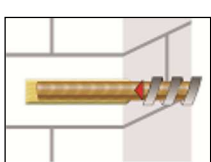
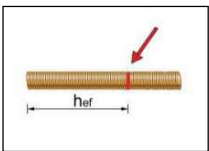

6. The position of the embedment depth shall be marked on the threaded rod. Push the threaded rod into the drill hole while turning slightly to ensure positive distribution of the adhesive until the embedment depth is reached. The anchor shall be free of dirt, grease, oil or other foreign material.

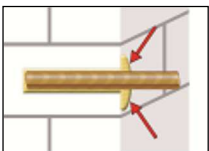

7. Be sure that the annular gap is fully filled with mortar. If no excess mortar is visible at the top of the hole, the application has to be renewed.

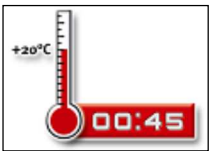

8. Allow the adhesive to cure to the specified time prior to applying any load or torque. Do not move or load the anchor until it is fully cured (attend Table B4).

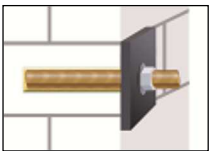

9. After full curing, the fixture can be installed with up to the max. torque (see parameters of brick Annex C4 to Annex C38) by using a calibrated torque wrench.

**Apolo MEA Injection System for masonry
ResiFIX PYSF, PYSF Change, PYSF Express, PYSF Tropical**

Intended use
Installation instruction Solid masonry and Autoclaved Aerated Concrete

Annex B 7

Installation instructions (continuation)

Installation in solid and hollow masonry (with sleeve)

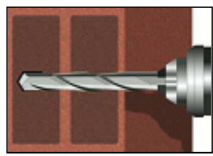

3. Holes to be drilled perpendicular to the surface of the base material by using a hard-metal tipped hammer drill bit. Drill a hole, with drill method according to Annex C4 – C39, into the base material, with nominal drill hole diameter and drill hole depth acc. to the size and embedment depth required by the selected anchor. In case of aborted drill hole the drill hole shall be filled with mortar.

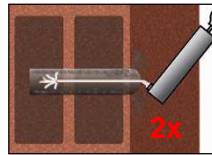
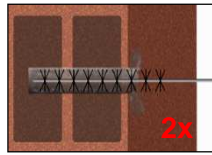
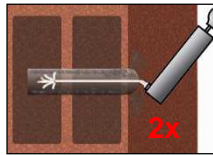

4. Blow out from the bottom of the drill hole two times. Attach the appropriate sized brush ($> d_{b,min}$ Table B2 or B3) to a drilling machine or a battery screwdriver, brush the hole clean two times, and finally blow out the hole again two times.

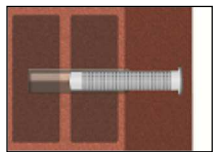

5. Insert the sleeve flush with the surface of the masonry. Only use sleeves that have the right length. Never cut the sleeve except the sleeve 16x130/330. For installing the sleeve 16x130/330 measure the required length of sleeve, cut the sleeve from the top and set the cap on it before pushing it through the fixing element.

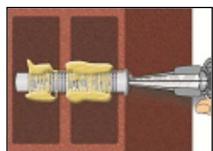

6. Starting from the bottom or back fill the sleeve with adhesive. For quantity of mortar attend cartridges label or installation instructions. Observe the gel-/ working times given in Table B4.

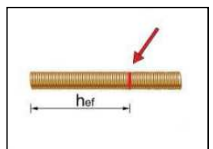

7. The position of the embedment depth shall be marked on the threaded rod. Push the threaded rod into the drill hole while turning slightly to ensure positive distribution of the adhesive until the embedment depth is reached. The anchor shall be free of dirt, grease, oil or other foreign material.

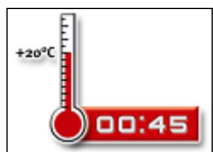

8. Allow the adhesive to cure to the specified curing time prior to applying any load or torque. Do not move or load the anchor until it is fully cured (attend Table B4).

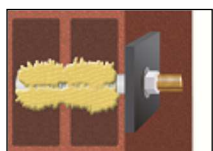

9. After full curing, the fixture can be installed with up to the max. torque (see parameters of brick Annex C4 to Annex C38) by using a calibrated torque wrench.

Apolo MEA Injection System for masonry
ResiFIX PYSF, PYSF Change, PYSF Express, PYSF Tropical

Intended use
 Installation instructions (hollow brick) and Solid lightweight Concrete

Annex B 8

Table C1: β -factors for job-site testing under tension loading

Brick-Nr.	Installation & Use category	Anchor size	β -factor	
			T _a : 24°C / 40°C	T _b : 50°C / 80°C
1-3	d/d	M8	0,82	0,70
		M10		
		M12	0,70	0,60
		M16		
	w/w	M8	0,82	0,70
		M10	0,63	0,54
		M12	0,48	0,41
		M16		
4-18	d/d w/d w/w	For all anchor	0,72	0,50

**Apolo MEA Injection System for masonry
ResiFIX PYSF, PYSF Change, PYSF Express, PYSF Tropical**

Performances
 β -factors for job site testing under tension load

Annex C 1

Table C2: Characteristic tension, shear resistance and bending moment of threaded rod

Size			M8	M10	M12	M16
Characteristic tension resistance						
steel, property class 4.6	$N_{Rk,s}$	[kN]	15	23	34	63
	$\gamma_{Ms}^{1)}$	[-]	2,0			
steel, property class 4.8	$N_{Rk,s}$	[kN]	15	23	34	63
	$\gamma_{Ms}^{1)}$	[-]	1,5			
steel, property class 5.6	$N_{Rk,s}$	[kN]	18	29	42	79
	$\gamma_{Ms}^{1)}$	[-]	2,0			
steel, property class 5.8	$N_{Rk,s}$	[kN]	18	29	42	79
	$\gamma_{Ms}^{1)}$	[-]	1,5			
steel, property class 8.8	$N_{Rk,s}$	[kN]	29	46	67	126
	$\gamma_{Ms}^{1)}$	[-]	1,5			
Stainless steel A4 / HCR, property class 70	$N_{Rk,s}$	[kN]	26	41	59	110
	$\gamma_{Ms}^{1)}$	[-]	1,87			
Stainless steel A4 / HCR, property class 80	$N_{Rk,s}$	[kN]	29	46	67	126
	$\gamma_{Ms}^{1)}$	[-]	1,6			
Characteristic shear resistance						
steel, property class 4.6	$V_{Rk,s}$	[kN]	7	12	17	31
	$\gamma_{Ms}^{1)}$	[-]	1,67			
steel, property class 4.8	$V_{Rk,s}$	[kN]	7	12	17	31
	$\gamma_{Ms}^{1)}$	[-]	1,25			
steel, property class 5.6	$V_{Rk,s}$	[kN]	9	15	21	39
	$\gamma_{Ms}^{1)}$	[-]	1,67			
steel, property class 5.8	$V_{Rk,s}$	[kN]	9	15	21	39
	$\gamma_{Ms}^{1)}$	[-]	1,25			
steel, property class 8.8	$V_{Rk,s}$	[kN]	15	23	34	63
	$\gamma_{Ms}^{1)}$	[-]	1,25			
Stainless steel A4 / HCR, property class 70	$V_{Rk,s}$	[kN]	13	20	30	55
	$\gamma_{Ms}^{1)}$	[-]	1,56			
Stainless steel A4 / HCR, property class 80	$V_{Rk,s}$	[kN]	15	23	34	63
	$\gamma_{Ms}^{1)}$	[-]	1,33			
Characteristic bending moment						
steel, property class 4.6	$M_{Rk,s}$	[Nm]	15	30	52	133
	$\gamma_{Ms}^{1)}$	[-]	1,67			
steel, property class 4.8	$M_{Rk,s}$	[Nm]	15	30	52	133
	$\gamma_{Ms}^{1)}$	[-]	1,25			
steel, property class 5.6	$M_{Rk,s}$	[Nm]	19	37	65	166
	$\gamma_{Ms}^{1)}$	[-]	1,67			
steel, property class 5.8	$M_{Rk,s}$	[Nm]	19	37	65	166
	$\gamma_{Ms}^{1)}$	[-]	1,25			
steel, property class 8.8	$M_{Rk,s}$	[Nm]	30	60	105	266
	$\gamma_{Ms}^{1)}$	[-]	1,25			
Stainless steel A4 / HCR, property class 70	$M_{Rk,s}$	[Nm]	26	52	92	232
	$\gamma_{Ms}^{1)}$	[-]	1,56			
Stainless steel A4 / HCR, property class 80	$M_{Rk,s}$	[Nm]	30	60	105	266
	$\gamma_{Ms}^{1)}$	[-]	1,33			

¹⁾ In absence of national regulations

**Apolo MEA Injection System for masonry
ResiFIX PYSF, PYSF Change, PYSF Express, PYSF Tropical**

Performances

Characteristic tension, shear resistance and bending moment of threaded rod

Annex C 2

Spacing and edge distances

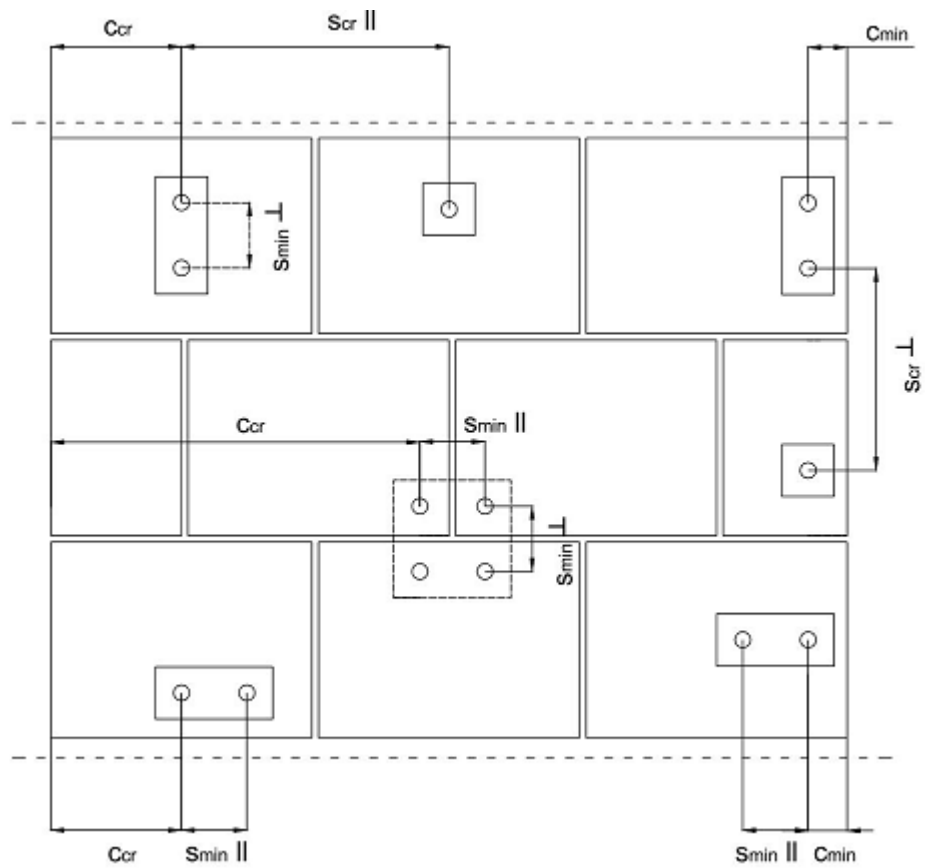

- C_{cr} = Characteristic edge distance
- $S_{scr II}$ = Characteristic spacing parallel to the bed joint
- $S_{scr \perp}$ = Characteristic spacing perpendicular to the bed joint
- C_{min} = Minimum edge distance
- $S_{min II}$ = Minimum spacing parallel to the bed joint
- $S_{min \perp}$ = Minimum spacing perpendicular to the bed joint

Apolo MEA Injection System for masonry
ResiFIX PYSF, PYSF Change, PYSF Express, PYSF Tropical

Performances
 Edge distance and anchor spacing

Annex C 3

Brick type: Autoclaved Aerated Concrete – AAC2

Table C3: Description

Brick type	Autoclaved Aerated Concrete AAC2	
Bulk density [kg/dm ³]	0,35	
Compressive strength [N/mm ²]	2	
Code	EN 771-4	
Producer (country code)	e.g. Ytong (CZ)	
Brick dimensions [mm]	599 x 375 x 249	
Drilling method	Rotary drilling	

Table C4: Installation parameter (Edge and spacing distances)

Anchor size	Effective anchorage depth	Edge distance	Spacing	Maximum installation torque
	h_{ef}	$c_{min} = c_{cr}$	$s_{cr} = s_{min \parallel} = s_{min \perp}$	$T_{inst,max}$
		[mm]		[Nm]
M8	80	120	240	2
M10	90	135	270	
M12	100	150	300	
M16	100	150	300	

Table C5: Displacement

Effective anchorage depth h_{ef}	N	δ_{N0}	$\delta_{N\infty}$	V	δ_{V0}	$\delta_{V\infty}$
[mm]	[kN]	[mm]	[mm]	[kN]	[mm]	[mm]
80	$\frac{N_{Rk}}{1,4 \cdot \gamma_M}$	0,29	0,58	$\frac{V_{Rk}}{1,4 \cdot \gamma_M}$	1,23	1,84
90		0,23	0,46		0,87	1,31
100		0,39	0,79		1,29	1,94

**Apolo MEA Injection System for masonry
ResiFIX PYSF, PYSF Change, PYSF Express, PYSF Tropical**

Performance Autoclaved Aerated Concrete – AAC2
Brick description, drawing,
Installation parameters, Displacements

Annex C 4

Brick type: Autoclaved Aerated Concrete AAC2

Table C6: Characteristic values of resistance under tension and shear loads

Anchor size	Effective anchorage depth	Characteristic resistance				
		Use category				
		d/d		w/d w/w		d/d w/d w/w
		40°C / 24°C	80°C / 50°C	40°C / 24°C	80°C / 50°C	For all temperature range
		$N_{Rk}^{1)}$	$N_{Rk}^{1)}$	$N_{Rk}^{1)}$	$N_{Rk}^{1)}$	$V_{Rk,b}^{2)}$
h_{ef}	[kN]					
[mm]						
Compressive strength $f_b \geq 2 \text{ N/mm}^2$						
M8	80	0,9	0,9	0,9	0,9	1,5
M10	90	0,9	0,9	0,9	0,75	2,0
M12	100	1,5	1,5	1,2	0,9	2,5
M16	100	1,5	1,5	1,2	0,9	3,5

¹⁾ For design according ETAG 029, Annex C: $N_{Rk} = N_{Rk,p} = N_{Rk,b}$; $N_{Rk,s}$ according to Table C2 Annex C2; Calculation $N_{Rk,pb}$ see ETAG 029, Annex C

²⁾ For $V_{Rk,s}$ see Annex C 2, Table C2; Calculation of $V_{Rk,pt}$ and $V_{Rk,c}$ see ETAG 029, Annex C

**Apolo MEA Injection System for masonry
ResiFIX PYSF, PYSF Change, PYSF Express, PYSF Tropical**

Performance Autoclaved Aerated Concrete – AAC2
Characteristic values of resistance under tension and shear load

Annex C 5

Brick type: Autoclaved Aerated Concrete AAC4

Table C7: Description

Brick type	Autoclaved Aerated Concrete AAC4	
Bulk density [kg/dm ³]	0,50	
Compressive strength [N/mm ²]	4	
Code	EN 771-4	
Producer (country code)	e.g. Ytong (CZ)	
Brick dimensions [mm]	499 x 375 x 249	
Drilling method	Rotary drilling	

Table C8: Installation parameter (Edge and spacing distances)

Anchor size	Effective anchorage depth	Edge distance	Spacing	Maximum installation torque
	h_{ef}	$c_{min} = c_{cr}$	$s_{cr} = s_{min \parallel} = s_{min \perp}$	$T_{inst,max}$
	[mm]			[Nm]
M8	80	120	240	2
M10	90	135	270	
M12	100	150	300	
M16	100	150	300	

Table C9: Displacement

Effective anchorage depth h_{ef}	N	δ_{N0}	$\delta_{N\infty}$	V	δ_{V0}	$\delta_{V\infty}$
[mm]	[kN]	[mm]	[mm]	[kN]	[mm]	[mm]
80	$\frac{N_{Rk}}{1,4 \cdot \gamma_M}$	0,23	0,47	$\frac{V_{Rk}}{1,4 \cdot \gamma_M}$	1,23	1,84
90		0,58	1,17		0,87	1,31
100		0,10	0,21		1,29	1,94

**Apolo MEA Injection System for masonry
ResiFIX PYSF, PYSF Change, PYSF Express, PYSF Tropical**

Performance Autoclaved Aerated Concrete – AAC4
Brick description, drawing,
Installation parameters, Displacement

Annex C 6

Brick type: Autoclaved Aerated Concrete AAC4

Table C10: Characteristic values of resistance under tension and shear loads

Anchor size	Effective anchorage depth	Characteristic resistance				
		Use category				
		d/d		w/d w/w		d/d w/d w/w
		40°C / 24°C	80°C / 50°C	40°C / 24°C	80°C / 50°C	For all temperature range
		$N_{Rk}^{1)}$	$N_{Rk}^{1)}$	$N_{Rk}^{1)}$	$N_{Rk}^{1)}$	$V_{Rk,b}^{2)}$
h_{ef}	[kN]					
[mm]						
Compressive strength $f_b \geq 4 \text{ N/mm}^2$						
M8	80	0,9	0,9	0,9	0,9	1,5
M10	90	2,5	2,0	1,5	1,5	2,0
M12	100	2,5	2,0	2,0	1,5	2,5
M16	100	3,5	3,0	2,0	2,0	3,5

¹⁾ For design according ETAG 029, Annex C: $N_{Rk} = N_{Rk,p} = N_{Rk,b}$; $N_{Rk,s}$ according to Table C2 Annex C2; Calculation $N_{Rk,pb}$ see ETAG 029, Annex C

²⁾ For $V_{Rk,s}$ see Annex C 2, Table C2; Calculation of $V_{Rk,pt}$ and $V_{Rk,c}$ see ETAG 029, Annex C

**Apolo MEA Injection System for masonry
ResiFIX PYSF, PYSF Change, PYSF Express, PYSF Tropical**

Performance Autoclaved Aerated Concrete – AAC4
Characteristic values of resistance under tension and shear load

Annex C 7

Brick type: Autoclaved Aerated Concrete AAC6

Table C11: Description

Brick type	Autoclaved Aerated Concrete AAC6	
Bulk density [kg/dm ³]	0,60	
Compressive strength [N/mm ²]	6	
Code	EN 771-4	
Producer (country code)	e.g. Porit (DE)	
Brick dimensions [mm]	499 x 240 x 249	
Drilling method	Rotary drilling	

Table C12: Installation parameter (Edge and spacing distances)

Anchor size	Effective anchorage depth	Edge distance	Spacing	Maximum installation torque
	h_{ef}	$c_{min} = c_{cr}$	$s_{cr} = s_{min \parallel} = s_{min \perp}$	$T_{inst,max}$
		[mm]		[Nm]
M8	80	120	240	2
M10	90	135	270	
M12	100	150	300	
M16	100	150	300	

Table C13: Displacement

Effective anchorage depth h_{ef}	N	δ_{N0}	$\delta_{N\infty}$	V	δ_{V0}	$\delta_{V\infty}$
[mm]	[kN]	[mm]	[mm]	[kN]	[mm]	[mm]
80	$\frac{N_{Rk}}{1,4 \cdot \gamma_M}$	0,54	1,09	$\frac{V_{Rk}}{1,4 \cdot \gamma_M}$	0,32	0,48
90		0,85	1,69		1,49	2,23
100		0,10	0,19		1,67	2,50

**Apolo MEA Injection System for masonry
ResiFIX PYSF, PYSF Change, PYSF Express, PYSF Tropical**

Performance Autoclaved Aerated Concrete – AAC6
Brick description, drawing,
Installation parameters, Displacements

Annex C 8

Brick type: Autoclaved Aerated Concrete AAC6

Table C14: Characteristic values of resistance under tension and shear loads

Anchor size	Effective anchorage depth	Characteristic resistance				
		Use category				
		d/d		w/d w/w		d/d w/d w/w
		40°C / 24°C	80°C / 50°C	40°C / 24°C	80°C / 50°C	For all temperature range
		$N_{Rk}^{1)}$	$N_{Rk}^{1)}$	$N_{Rk}^{1)}$	$N_{Rk}^{1)}$	$V_{Rk,b}^{2)}$
h_{ef}	[kN]					
[mm]						
Compressive strength $f_b \geq 6 \text{ N/mm}^2$						
M8	80	2,0	2,0	2,0	2,0	5,5
M10	90	3,0	2,5	2,5	2,0	9,0
M12	100	4,5	3,5	3,0	2,5	9,0
M16	100	5,5	4,5	3,5	3,0	11,0

¹⁾ For design according ETAG 029, Annex C: $N_{Rk} = N_{Rk,p} = N_{Rk,b}$; $N_{Rk,s}$ according to Table C2 Annex C2; Calculation $N_{Rk,pb}$ see ETAG 029, Annex C

²⁾ For $V_{Rk,s}$ see Annex C 2, Table C2; Calculation of $V_{Rk,pt}$ and $V_{Rk,c}$ see ETAG 029, Annex C

**Apolo MEA Injection System for masonry
ResiFIX PYSF, PYSF Change, PYSF Express, PYSF Tropical**

Performance Autoclaved Aerated Concrete – AAC6
Characteristic values of resistance under tension and shear load

Annex C 9

Brick type: Calcium silicate solid brick KS-NF

Table C15: Description

Brick type	Calcium silicate solid brick KS-NF	
Bulk density [kg/dm ³]	2,0	
Compressive strength [N/mm ²]	10, 20 or 27	
Code	EN 771-2	
Producer (country code)	e.g. Wemding (DE)	
Brick dimensions [mm]	240 x 115 x 71	
Drilling method	Hammer drilling	

Table C16: Installation parameter (Edge and spacing distances)

Anchor size	Sleeve	Embedment depth	Edge distance	Spacing	Maximum installation torque
		h_{ef}	$c_{min} = c_{cr}$	$s_{cr} = s_{min II} = s_{min \perp}$	$T_{inst,max}$
		[mm]			[Nm]
M8	-	80	120	240	10
M10	-	90	135	270	20
M12 / M16	-	100	150	300	
M8	SH 12x80	80	120	240	10
	SH 16x85	85	127	255	
M10	SH 16x85	85	127	255	20
M8 / M10	SH 16x130	130	195	390	
	SH 16x130/330	130	195	390	
M12 / M16	SH 20x85	85	127	255	
	SH 20x130	130	195	390	
	SH 20x200	200	300	600	

Table C17: Displacement

Effective anchorage depth h_{ef}	N	δ_{N0}	$\delta_{N\infty}$	V	δ_{V0}	$\delta_{V\infty}$
[mm]	[kN]	[mm]	[mm]	[kN]	[mm]	[mm]
80	$\frac{N_{Rk}}{1,4 \cdot \gamma_M}$	0,08	0,16	$\frac{V_{Rk}}{1,4 \cdot \gamma_M}$	3,07	4,61
85		0,26	0,52		1,46	2,19
90		0,09	0,18		1,50	2,25
100		0,10	0,20		1,03	1,53
130 ; 200		0,22	0,44		1,16	1,74

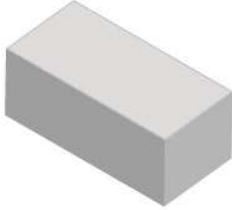
**Apolo MEA Injection System for masonry
ResiFIX PYSF, PYSF Change, PYSF Express, PYSF Tropical**

Performance Calcium solid brick KS-NF
Brick description, drawing,
Installation parameters, Displacements

Annex C 10

Brick type: Calcium silicate solid brick KS-NF

Table C18: Characteristic values of resistance under tension and shear loads

Anchor size	Sleeve	Effective anchorage depth h_{ef} [mm]	Characteristic resistance		
			Use category d/d; w/d; w/w		
			40°C / 24°C	80°C / 50°C	For all temperature range
			$N_{Rk}^{1)}$	$N_{Rk}^{1)}$	$V_{Rk,b}^{2)}$
			[kN]		
Compressive strength $f_b \geq 10 \text{ N/mm}^2$					
M8	-	80	3,0	2,0	3,0
M10	-	90	3,0	2,0	3,0
M12	-	100	4,0	2,5	3,5
M16	-	100	3,0	2,0	3,5
M8	SH 12x80	80	2,5	2,0	2,5
	SH 16x85	85	2,5	2,0	3,0
	SH16x130 / SH16x130/330	130	4,0	2,5	4,0
M10	SH 16x85	85	2,5	2,0	3,0
	SH16x130/330	130	4,5	3,0	4,0
M12 / M16	SH 20x85	85	2,5	2,0	3,0
	SH 20x130 / SH 20x200	130 / 200	4,5	2,5	4,0
Compressive strength $f_b \geq 20 \text{ N/mm}^2$					
M8	-	80	4,5	3,0	4,5
M10	-	90	4,5	3,0	4,5
M12	-	100	5,5	3,5	5,0
M16	-	100	4,5	3,0	5,0
M8	SH 12x80	80	4,0	2,5	4,0
	SH 16x85	85	4,0	2,5	4,5
	SH16x130 / SH16x130/330	130	6,0	3,5	5,5
M10	SH 16x85	85	4,0	2,5	4,5
	SH 16x130/330	130	6,0	4,0	5,5
M12 / M16	SH 20x85	85	4,0	2,5	5,0
	SH 20x130 / SH 20x200	130 / 200	6,0	4,0	5,5
Compressive strength $f_b \geq 27 \text{ N/mm}^2$					
M8	-	80	5,5	3,5	5,0
M10	-	90	5,5	3,5	5,5
M12	-	100	6,5	4,5	6,0
M16	-	100	5,5	3,5	6,0
M8	SH 12x80	80	4,5	3,0	4,5
	SH 16x85	85	4,5	3,0	5,5
	SH16x130 / SH16x130/330	130	6,5	4,5	6,5
M10	SH 16x85	85	4,5	3,0	5,5
	SH 16x130/330	130	6,5	4,5	6,5
M12 / M16	SH 20x85	85	4,5	3,0	5,5
	SH 20x130 / SH 20x200	130 / 200	6,5	4,5	6,5

¹⁾ For design according ETAG 029, Annex C: $N_{Rk} = N_{Rk,p} = N_{Rk,b}$; $N_{Rk,s}$ according to Table C2 Annex C2; Calculation $N_{Rk,pb}$ see ETAG 029, Annex C

²⁾ For $V_{Rk,s}$ see Annex C 2, Table C2; Calculation of $V_{Rk,pb}$ and $V_{Rk,c}$ see ETAG 029, Annex C

**Apolo MEA Injection System for masonry
ResiFIX PYSF, PYSF Change, PYSF Express, PYSF Tropical**

Performance Calcium solid brick KS-NF
Characteristic values of resistance under tension and shear load

Annex C 11

Brick type: Calcium silicate hollow brick KS L-3DF

Table C19: Description

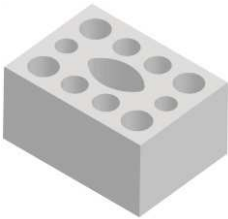
Brick type	Calcium silicate hollow brick KS L-3DF	
Bulk density [kg/dm ³]	1,4	
Compressive strength [N/mm ²]	8, 12 or 14	
Code	EN 771-2	
Producer (country code)	e.g. Wemding (DE)	
Brick dimensions [mm]	240 x 175 x 113	
Drilling method	Rotary drilling	

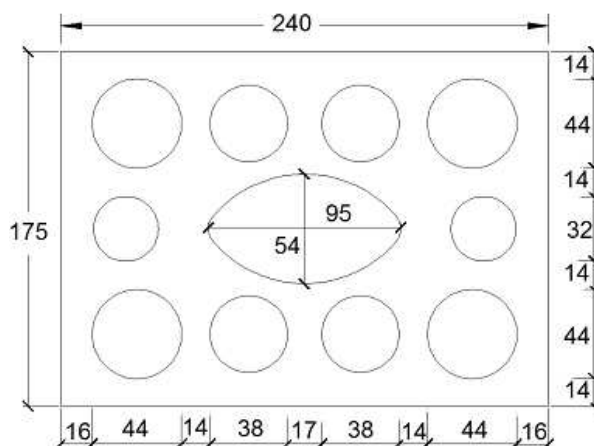

Table C20: Installation parameter (Edge and spacing distances)

Anchor size	Sleeve	Embedment depth h_{ef}	Edge distance $C_{min} = C_{cr}$	Spacing		Maximum installation torque $T_{inst,max}$ [Nm]
				$S_{cr} = S_{min II}$	$S_{min \perp}$	
[mm]						
M8	SH 12x80	80	100	240	113	8
M8 / M10	SH 16x85	85				
	SH 16x130	130				
	SH 16x130/330	130				
M12 / M16	SH 20x85	85	120	240	113	8
	SH 20x130	130				
	SH 20x200	200				

Table C21: Displacement

Effective anchorage depth h_{ef}	N	δ_{N0}	$\delta_{N\infty}$	V	δ_{V0}	$\delta_{V\infty}$
[mm]	[kN]	[mm]	[mm]	[kN]	[mm]	[mm]
80	$\frac{N_{Rk}}{1,4 \cdot \gamma_M}$	0,36	0,73	$\frac{V_{Rk}}{1,4 \cdot \gamma_M}$	0,82	1,23
85		1,62	3,24		1,83	2,75
130 ; 200		1,70	3,40		1,98	2,98

Apolo MEA Injection System for masonry
ResiFIX PYSF, PYSF Change, PYSF Express, PYSF Tropical

Performance Calcium hollow brick KS L-3DF
 Brick description, drawing,
 Installation parameters, Displacements

Annex C 12

Brick type: Calcium silicate hollow brick KS L-3DF

Table C22: Characteristic values of resistance under tension and shear loads

Anchor size	Sleeve	Effective anchorage depth	Characteristic resistance		
			Use category		
			d/d w/d w/w		
			40°C / 24°C	80°C / 50°C	For all temperature range
h_{ef} [mm]	$N_{Rk}^{1)}$ [kN]	$N_{Rk}^{1)}$ [kN]	$V_{Rk,b}^{2)}$		
Compressive strength $f_b \geq 8 \text{ N/mm}^2$					
M8	SH 12x80	80	1,5	0,9	2,0
	SH 16x85	85	1,5	0,9	2,5
	SH 16x130	130	2,5	1,5	3,0
	SH 16x130/330	130	2,5	1,5	3,0
M10	SH 16x85	85	1,5	0,9	2,5
	SH 16x130	130	2,5	1,5	3,0
	SH 16x130/330	130	2,5	1,5	3,0
M12	SH 20x85	85	1,5	0,9	3,0
	SH 20x130 / SH 20x200	130 / 200	2,5	1,5	3,0
M16	SH 20x85	85	1,5	0,9	3,0
	SH 20x130 / SH 20x200	130 / 200	2,5	1,5	4,0
Compressive strength $f_b \geq 12 \text{ N/mm}^2$					
M8	SH 12x80	80	2,0	1,2	2,5
	SH 16x85	85	2,0	1,2	3,5
	SH 16x130	130	3,5	2,0	4,5
	SH 16x130/330	130	3,5	2,0	4,5
M10	SH 16x85	85	2,0	1,2	3,5
	SH 16x130	130	3,5	2,0	4,5
	SH 16x130/330	130	3,5	2,0	4,5
M12	SH 20x85	85	2,0	1,2	3,5
	SH 20x130 / SH 20x200	130 / 200	3,5	2,0	4,5
M16	SH 20x85	85	2,0	1,2	3,5
	SH 20x130 / SH 20x200	130 / 200	3,5	2,0	5,0
Compressive strength $f_b \geq 14 \text{ N/mm}^2$					
M8	SH 12x80	80	2,5	1,5	3,0
	SH 16x85	85	2,5	1,5	4,0
	SH 16x130	130	4,0	3,0	5,0
	SH 16x130/330	130	4,0	3,0	5,0
M10	SH 16x85	85	2,5	1,5	4,0
	SH 16x130	130	4,0	3,0	5,0
	SH 16x130/330	130	4,0	3,0	5,0
M12	SH 20x85	85	2,5	1,5	4,5
	SH 20x130 / SH 20x200	130 / 200	4,0	3,0	5,0
M16	SH 20x85	85	2,5	1,5	4,5
	SH 20x130 / SH 20x200	130 / 200	4,0	3,0	6,0

¹⁾ For design according ETAG 029, Annex C: $N_{Rk} = N_{Rk,p} = N_{Rk,b}$; $N_{Rk,s}$ according to Table C2 Annex C2; Calculation $N_{Rk,pb}$ see ETAG 029, Annex C

²⁾ For $V_{Rk,s}$ see Annex C 2, Table C2; Calculation of $V_{Rk,pt}$ and $V_{Rk,c}$ see ETAG 029, Annex C

**Apolo MEA Injection System for masonry
ResiFIX PYSF, PYSF Change, PYSF Express, PYSF Tropical**

Performance Calcium hollow brick KS L-3DF
Characteristic values of resistance under tension and shear load

Annex C 13

Brick type: Calcium silicate hollow brick KS L-12DF

Table C23: Description

Brick type	Calcium silicate hollow brick KS L-12DF	
Bulk density [kg/dm³]	1,40	
Compressive strength [N/mm²]	10, 12 or 16	
Code	EN 771-2	
Producer (country code)	e.g. Wemding (DE)	
Brick dimensions [mm]	498 x 175 x 238	
Drilling method	Rotary drilling	

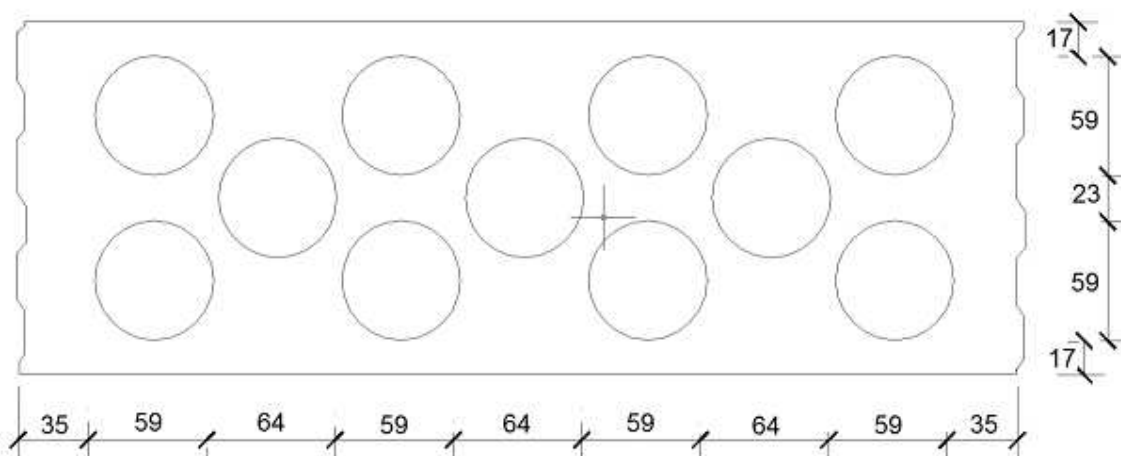

Table C24: Installation parameter (Edge and spacing distances)

Anchor size	Sleeve	Embedment depth	Edge distance	Spacing		Maximum installation torque
				$C_{min} = C_{cr}$	$S_{cr} = S_{min \parallel}$	
		h_{ef}		[mm]		[Nm]
M8	SH 12x80	80	100	498	238	2
M8 / M10	SH 16x85	85				4
	SH 16x130	130				
	SH 16x130/330	130				
M12 / M16	SH 20x85	85	120			
	SH 20x130	130				

Table C25: Displacement

Effective anchorage depth h_{ef}	N	δ_{N0}	$\delta_{N\infty}$	V	δ_{V0}	$\delta_{V\infty}$
[mm]	[kN]	[mm]	[mm]	[kN]	[mm]	[mm]
80	$\frac{N_{Rk}}{1,4 \cdot \gamma_M}$	0,21	0,42	$\frac{V_{Rk}}{1,4 \cdot \gamma_M}$	1,77	2,66
85		0,13	0,26		3,89	5,83
130		0,22	0,44		4,35	6,52

Apolo MEA Injection System for masonry
ResiFIX PYSF, PYSF Change, PYSF Express, PYSF Tropical

Performance Calcium hollow brick KS L-12DF
 Brick description, drawing,
 Installation parameters, Displacement

Annex C 14

Brick type: Calcium silicate hollow brick KS L-12DF

Table C26: Characteristic values of resistance under tension and shear loads

Anchor size	Sleeve	Effective anchorage depth h_{ef} [mm]	Characteristic resistance		
			Use category d/d w/d w/w		
			40°C / 24°C	80°C / 50°C	For all temperature range
			$N_{RK}^{1)}$	$N_{RK}^{1)}$	$V_{RK,b}^{2)}$
			[kN]		
Compressive strength $f_b \geq 10 \text{ N/mm}^2$					
M8	SH 12x80	80	0,4	0,3	3,0
	SH 16x85	85	1,2	0,9	6,0
	SH 16x130	130	3,5	2,5	7,0
	SH 16x130/330	130	3,5	2,5	7,0
M10	SH 16x85	85	1,2	0,9	6,0
	SH 16x130	130	3,5	2,5	7,0
	SH 16x130/330	130	3,5	2,5	7,0
M12 / M16	SH 20x85	85	1,2	0,9	6,0
	SH 20x130 / SH 20x200	130 / 200	3,5	2,5	7,0
Compressive strength $f_b \geq 12 \text{ N/mm}^2$					
M8	SH 12x80	80	0,4	0,3	3,5
	SH 16x85	85	1,5	0,9	7,0
	SH 16x130	130	4,5	3,0	8,0
	SH 16x130/330	130	4,5	3,0	8,0
M10	SH 16x85	85	1,5	0,9	7,0
	SH 16x130	130	4,5	3,0	8,0
	SH 16x130/330	130	4,5	3,0	8,0
M12 / M16	SH 20x85	85	1,5	0,9	7,0
	SH 20x130 / SH 20x200	130 / 200	4,5	3,0	8,0
Compressive strength $f_b \geq 16 \text{ N/mm}^2$					
M8	SH 12x80	80	0,5	0,4	4,0
	SH 16x85	85	2,0	1,2	9,0
	SH 16x130	130	5,5	3,5	10,0
	SH 16x130/330	130	5,5	3,5	10,0
M10	SH 16x85	85	2,0	1,2	9,0
	SH 16x130	130	5,5	3,5	10,0
	SH 16x130/330	130	5,5	3,5	10,0
M12 / M16	SH 20x85	85	2,0	1,2	8,5
	SH 20x130 / SH 20x200	130 / 200	5,5	3,5	10,0

1) For design according ETAG 029, Annex C: $N_{RK} = N_{RK,p} = N_{RK,b}$; $N_{RK,s}$ according to Table C2 Annex C2; Calculation $N_{RK,pb}$ see ETAG 029, Annex C

2) For $V_{RK,s}$ see Annex C 2, Table C2; Calculation of $V_{RK,pt}$ and $V_{RK,c}$ see ETAG 029, Annex C

**Apolo MEA Injection System for masonry
ResiFIX PYSF, PYSF Change, PYSF Express, PYSF Tropical**

Performance Calcium hollow brick KS L-12DF
Characteristic values of resistance under tension and shear load

Annex C 15

Brick type: Clay solid brick Mz-DF

Table C27: Description

Brick type	Clay solid brick Mz-DF	
Bulk density [kg/dm³]	1,64	
Compressive strength [N/mm²]	10, 20 or 28	
Code	EN 771-1	
Producer (country code)	e.g. Unipor (DE)	
Brick dimensions [mm]	240 x 115 x 55	
Drilling method	Hammer drilling	

Table C28: Installation parameter (Edge and spacing distances)

Anchor size	Sleeve	Embedment depth	Edge distance	Spacing	Maximum installation torque
			$C_{min} = C_{Cr}$	$S_{Cr} = S_{min \parallel} = S_{min \perp}$	
		h_{ef}	[mm]		$T_{inst,max}$
					[Nm]
M8	-	80	120	240	6
	SH 12x80	80	120	240	
	SH 16x85	85	127	255	
M10	-	90	135	270	10
M12 / M16	-	100	150	300	
M10	SH 16x85	85	127	255	8
	SH 16x130	130	195	390	
	SH 16x130/330	130	195	390	
M12 / M16	SH 20x85	85	127	255	
	SH 20x130	130	195	390	
	SH 20x200	200	300	600	

Table C29: Displacement

Effective anchorage depth h_{ef}	N	δ_{N0}	$\delta_{N\infty}$	V	δ_{V0}	$\delta_{V\infty}$
[mm]	[kN]	[mm]	[mm]	[kN]	[mm]	[mm]
80	$\frac{N_{Rk}}{1,4 \cdot \gamma_M}$	0,12	0,24	$\frac{V_{Rk}}{1,4 \cdot \gamma_M}$	2,27	3,41
85		0,13	0,26		1,22	1,83
90		0,06	0,13		0,71	1,06
100		0,18	0,35		0,43	0,64
130 ; 200		0,42	0,85		1,22	1,83

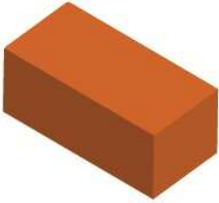
**Apolo MEA Injection System for masonry
ResiFIX PYSF, PYSF Change, PYSF Express, PYSF Tropical**

Performance Clay solid brick Mz-DF
Brick description, drawing,
Installation parameters, Displacements

Annex C 16

Brick type: Clay solid brick Mz-DF

Table C30: Characteristic values of resistance under tension and shear loads

Anchor size	Sleeve	Effective anchorage depth	Characteristic resistance		
			Use category		
			40°C / 24°C	80°C / 50°C	For all temperature range
h_{ef}		$N_{Rk}^{1)}$	$N_{Rk}^{1)}$	$V_{Rk,b}^{2)}$	
		[mm]	[kN]		
Compressive strength $f_b \geq 10 \text{ N/mm}^2$					
M8	-	80	1,5	1,2	3,0
M10	-	90	1,5	1,2	3,5
M12	-	100	1,5	0,9	5,0
M16	-	100	2,5	1,5	5,0
M8	SH 12x80	80	2,0	1,5	3,0
	SH 16x85	85	2,0	1,5	3,0
	SH 16x130 / SH 16x130/330	130	3,0	2,0	3,0
M10	SH 16x85	85	2,0	1,5	3,5
	SH 16x130 / SH 16x130/330	130	3,0	2,0	3,5
M12 / M16	SH 20x85	85	2,0	1,5	3,5
	SH 20x130 / SH 20x200	130 / 200	3,0	2,0	3,5
Compressive strength $f_b \geq 20 \text{ N/mm}^2$					
M8	-	80	2,5	1,5	4,5
M10	-	90	2,5	1,5	5,5
M12	-	100	2,0	1,5	7,5
M16	-	100	3,5	2,5	7,5
M8	SH 12x80	80	3,0	2,0	4,0
	SH 16x85	85	3,0	2,0	4,5
	SH 16x130 / SH 16x130/330	130	4,0	2,5	4,5
M10	SH 16x85	85	3,0	2,0	5,0
	SH 16x130 / SH 16x130/330	130	4,5	3,0	5,0
M12 / M16	SH 20x85	85	3,0	2,0	5,0
	SH 20x130 / SH 20x200	130 / 200	4,5	3,0	5,0
Compressive strength $f_b \geq 28 \text{ N/mm}^2$					
M8	-	80	3,0	2,0	5,5
M10	-	90	3,0	2,0	6,5
M12	-	100	2,5	1,5	9,0
M16	-	100	4,5	3,0	9,0
M8	SH 12x80	80	3,5	2,5	5,0
	SH 16x85	85	3,5	2,5	5,0
	SH 16x130 / SH 16x130/330	130	5,0	3,5	5,0
M10	SH 16x85	85	3,5	2,5	6,0
	SH 16x130 / SH 16x130/330	130	5,0	3,5	6,0
M12 / M16	SH 20x85	85	3,5	2,5	6,0
	SH 20x130 / SH 20x200	130 / 200	5,0	3,5	6,0

¹⁾ For design according ETAG 029, Annex C: $N_{Rk} = N_{Rk,p} = N_{Rk,b}$; $N_{Rk,s}$ according to Table C2 Annex C2; Calculation $N_{Rk,pb}$ see ETAG 029, Annex C

²⁾ For $V_{Rk,s}$ see Annex C 2, Table C2; Calculation of $V_{Rk,pb}$ and $V_{Rk,c}$ see ETAG 029, Annex C

Apolo MEA Injection System for masonry
ResiFIX PYSF, PYSF Change, PYSF Express, PYSF Tropical

Performance Clay solid brick Mz-DF
 Characteristic values of resistance under tension and shear load

Annex C 17

Brick type: Clay hollow brick HLz-16DF

Table C31: Description

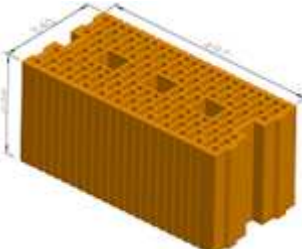
Brick type	Clay hollow brick HLz-16DF	
Bulk density [kg/dm³]	0,83	
Compressive strength [N/mm²]	6, 9, 12 or 14	
Code	EN 771-1	
Producer (country code)	e.g. Unipor (DE)	
Brick dimensions [mm]	497 x 238 x 240	
Drilling method	Rotary drilling	

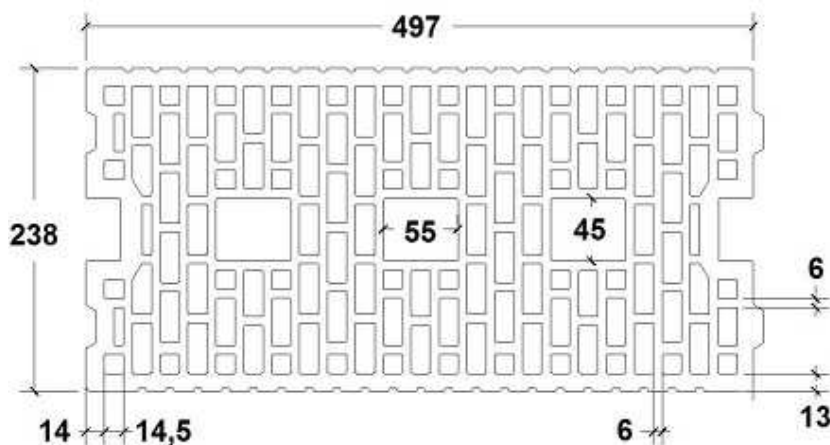

Table C32: Installation parameter (Edge and spacing distances)

Anchor size	Sleeve	Embedment depth	Edge distance	Spacing		Maximum installation torque
				$C_{min} = C_{cr}$	$S_{cr} = S_{min \parallel}$	
		h_{ef}		[mm]		[Nm]
M8	SH 12x80	80	100	497	238	6
M8 / M10	SH 16x85	85				
	SH 16x130	130				
	SH 16x130/330	130				
M12 / M16	SH 20x85	85	120	497	238	6
	SH 20x130	130				
	SH 20x200	200				

Table C33: Displacement

Effective anchorage depth h_{ef}	N	δ_{N0}	$\delta_{N\infty}$	V	δ_{V0}	$\delta_{V\infty}$
[mm]	[kN]	[mm]	[mm]	[kN]	[mm]	[mm]
80	$\frac{N_{Rk}}{1,4 \cdot \gamma_M}$	0,27	0,55	$\frac{V_{Rk}}{1,4 \cdot \gamma_M}$	1,02	1,53
85		0,55	1,10		2,14	3,22
130 ; 200		0,19	0,38		2,26	3,39

Apolo MEA Injection System for masonry
ResiFIX PYSF, PYSF Change, PYSF Express, PYSF Tropical

Performance Clay hollow brick HLz-16DF
 Brick description, drawing,
 Installation parameters, Displacements

Annex C 18

Brick type: Clay hollow brick HLz-16DF

Table C34: Characteristic values of resistance under tension and shear loads

Anchor size	Sleeve	Effective anchorage depth	Characteristic resistance		
			Use category d/d; w/d; w/w		
			40°C / 24°C	80°C / 50°C	For all temperature range
			$N_{Rk}^{1)}$	$N_{Rk}^{1)}$	$V_{Rk,b}^{2)}$
		[mm]	[kN]		
Compressive strength $f_b \geq 6 \text{ N/mm}^2$					
M8	SH 12x80	80	1,2	0,75	2,5
	SH 16x85	85	1,5	1,2	4,0
	SH 16x130	130	2,5	1,5	4,0
	SH 16x130/330	130	2,5	1,5	4,0
M10	SH 16x85	85	1,5	1,2	4,0
	SH 16x130	130	2,5	1,5	6,0
	SH 16x130/330	130	2,5	1,5	6,0
M12 / M16	SH 20x85	85	2,0	1,5	4,0
	SH 20x130 / SH 20x200	130/ 200	2,5	1,5	6,0
Compressive strength $f_b \geq 9 \text{ N/mm}^2$					
M8	SH 12x80	80	1,2	0,9	3,0
	SH 16x85	85	2,0	1,5	4,5
	SH 16x130	130	3,0	2,0	5,0
	SH 16x130/330	130	3,0	2,0	5,0
M10	SH 16x85	85	2,0	1,5	5,0
	SH 16x130	130	3,0	2,0	7,0
	SH 16x130/330	130	3,0	2,0	7,0
M12 / M16	SH 20x85	85	2,5	2,0	5,0
	SH 20x130 / SH 20x200	130/ 200	3,0	2,0	7,0
Compressive strength $f_b \geq 12 \text{ N/mm}^2$					
M8	SH 12x80	80	1,5	1,2	3,5
	SH 16x85	85	2,5	1,5	5,5
	SH 16x130	130	3,5	2,5	6,0
	SH 16x130/330	130	3,5	2,5	6,0
M10	SH 16x85	85	2,5	1,5	6,0
	SH 16x130	130	3,5	2,5	8,0
	SH 16x130/330	130	3,5	2,5	8,0
M12 / M16	SH 20x85	85	3,5	2,0	6,0
	SH 20x130 / SH 20x200	130/ 200	3,5	2,5	8,0
Compressive strength $f_b \geq 14 \text{ N/mm}^2$					
M8	SH 12x80	80	1,5	1,2	4,0
	SH 16x85	85	2,5	2,0	6,0
	SH 16x130	130	3,5	2,5	6,5
	SH 16x130/330	130	3,5	2,5	6,5
M10	SH 16x85	85	2,5	2,0	6,0
	SH 16x130	130	3,5	2,5	9,0
	SH 16x130/330	130	3,5	2,5	9,0
M12 / M16	SH 20x85	85	3,5	2,0	6,0
	SH 20x130 / SH 20x200	130/ 200	3,5	2,5	9,0

1) For design according ETAG 029, Annex C: $N_{Rk} = N_{Rk,p} = N_{Rk,b}$; $N_{Rk,s}$ according to Table C2 Annex C2; Calculation $N_{Rk,pb}$ see ETAG 029, Annex C

2) For $V_{Rk,s}$ see Annex C 2, Table C2; Calculation of $V_{Rk,pb}$ and $V_{Rk,c}$ see ETAG 029, Annex C

**Apolo MEA Injection System for masonry
ResiFIX PYSF, PYSF Change, PYSF Express, PYSF Tropical**

Performance Clay hollow brick HLz-16DF
Characteristic values of resistance under tension and shear load

Annex C 19

Brick type: Clay hollow brick Porotherm Homebric

Table C35: Description

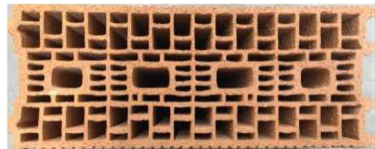
Brick type	Clay hollow brick Porotherm Homebric	
Bulk density [kg/dm³]	0,68	
Compressive strength [N/mm²]	6, 8 or 10	
Code	EN 771-1	
Producer (country code)	e.g. Wienerberger (FR)	
Brick dimensions [mm]	500 x 200 x 299	
Drilling method	Rotary drilling	

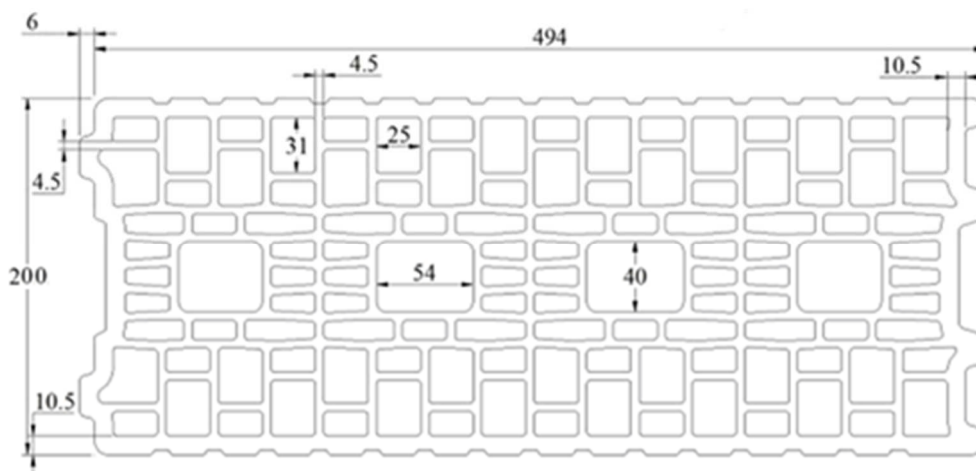

Table C36: Installation parameter (Edge and spacing distances)

Anchor size	Sleeve	Embedment depth	Edge distance	Spacing		Maximum installation torque
				$S_{cr} = S_{min II}$	$S_{min \perp}$	
			$C_{min} = C_{cr}$	[mm]		$T_{inst,max}$
						[Nm]
M8	SH 12x80	80	100	500	299	2
M8 / M10	SH 16x85	85				6
	SH 16x130	130				
M12 / M16	SH 16x130/330	130	120	500	299	6
	SH 20x85	85				
	SH 20x130	130				

Table C37: Displacement

Effective anchorage depth h_{ef}	N	δ_{N0}	$\delta_{N\infty}$	V	δ_{V0}	$\delta_{V\infty}$
[mm]	[kN]	[mm]	[mm]	[kN]	[mm]	[mm]
80	$\frac{N_{Rk}}{1,4 \cdot \gamma_M}$	0,65	1,29	$\frac{V_{Rk}}{1,4 \cdot \gamma_M}$	1,26	1,89
85		0,52	1,04		1,89	2,84
130		0,45	0,90		1,48	2,23

Apolo MEA Injection System for masonry
ResiFIX PYSF, PYSF Change, PYSF Express, PYSF Tropical

Performance Clay hollow brick Porotherm Homebric
 Brick description, drawing,
 Installation parameters, Displacements

Annex C 20

Brick type: Clay hollow brick Porotherm Homebric

Table C38: Characteristic values of resistance under tension and shear loads

Anchor size	Sleeve	Effective anchorage depth	Characteristic resistance		
			Use category		
			d/d	w/d	w/w
			40°C / 24°C	80°C / 50°C	For all temperature range
h_{ef}	$N_{Rk}^{1)}$	$N_{Rk}^{1)}$	$V_{Rk,b}^{2)}$		
[mm]	[kN]				
Compressive strength $f_b \geq 6 \text{ N/mm}^2$					
M8	SH 12x80	80	0,9	0,75	2,0
	SH 16x85	85	1,2	0,75	2,0
	SH 16x130	130	1,5	0,9	2,5
	SH 16x130/330	130	1,5	0,9	2,5
M10	SH 16x85	85	1,2	0,75	2,0
	SH 16x130	130	1,5	0,9	2,5
	SH 16x130/330	130	1,5	0,9	2,5
M12	SH 20x85	85	1,2	0,75	3,0
	SH 20x130	130	1,5	0,9	3,0
M16	SH 20x85	85	1,2	0,75	3,0
	SH 20x130	130	1,5	0,9	3,0
Compressive strength $f_b \geq 8 \text{ N/mm}^2$					
M8	SH 12x80	80	1,2	0,9	2,5
	SH 16x85	85	1,2	0,9	2,5
	SH 16x130	130	1,5	1,2	3,0
	SH 16x130/330	130	1,5	1,2	3,0
M10	SH 16x85	85	1,2	0,9	2,5
	SH 16x130	130	1,5	1,2	3,0
	SH 16x130/330	130	1,5	1,2	3,0
M12	SH 20x85	85	1,2	0,9	3,5
	SH 20x130	130	1,5	1,2	3,5
M16	SH 20x85	85	1,2	0,9	3,5
	SH 20x130	130	1,5	1,2	3,5
Compressive strength $f_b \geq 10 \text{ N/mm}^2$					
M8	SH 12x80	80	1,2	0,9	3,0
	SH 16x85	85	1,5	0,9	3,0
	SH 16x130	130	2,0	1,2	3,5
	SH 16x130/330	130	2,0	1,2	3,5
M10	SH 16x85	85	1,5	0,9	3,0
	SH 16x130	130	2,0	1,2	3,5
	SH 16x130/330	130	2,0	1,2	3,5
M12	SH 20x85	85	1,5	0,9	4,0
	SH 20x130	130	2,0	1,2	4,0
M16	SH 20x85	85	1,5	0,9	4,0
	SH 20x130	130	2,0	1,2	4,0

¹⁾ For design according ETAG 029, Annex C: $N_{Rk} = N_{Rk,p} = N_{Rk,b}$; $N_{Rk,s}$ according to Table C2 Annex C2; Calculation $N_{Rk,pb}$ see ETAG 029, Annex C

²⁾ For $V_{Rk,s}$ see Annex C 2, Table C2; Calculation of $V_{Rk,pt}$ and $V_{Rk,c}$ see ETAG 029, Annex C

**Apolo MEA Injection System for masonry
ResiFIX PYSF, PYSF Change, PYSF Express, PYSF Tropical**

Performance Clay hollow brick Porotherm Homebric
Characteristic values of resistance under tension and shear load

Annex C 21

Brick type: Clay hollow brick BGV Thermo

Table C39: Description

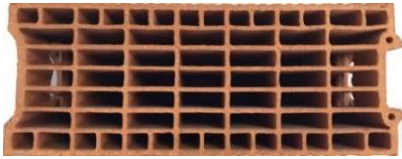
Brick type	Clay hollow brick BGV Thermo	
Bulk density [kg/dm³]	0,62	
Compressive strength [N/mm²]	4, 6 or 10	
Code	EN 771-1	
Producer (country code)	e.g. Leroux (FR)	
Brick dimensions [mm]	500 x 200 x 314	
Drilling method	Rotary drilling	

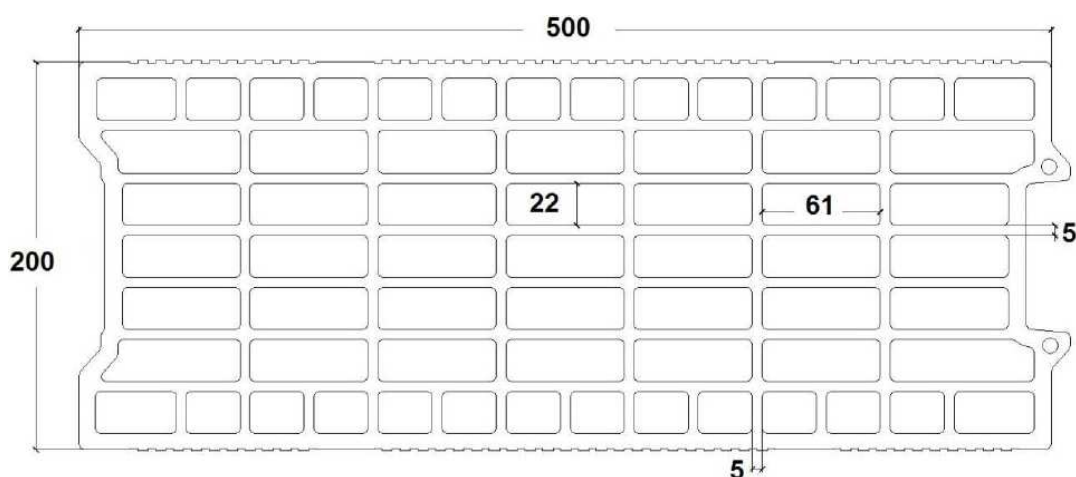

Table C40: Installation parameter (Edge and spacing distances)

Anchor size	Sleeve	Embedment depth	Edge distance	Spacing		Maximum installation torque
				$S_{cr} = S_{min \parallel}$	$S_{min \perp}$	
		h_{ef}	$C_{min} = C_{cr}$	[mm]		$T_{inst,max}$ [Nm]
M8	SH 12x80	80	100	500	314	2
M8 / M10	SH 16x85	85				4
	SH 16x130	130				
M12 / M16	SH 16x130/330	130	120	500	314	4
	SH 20x85	85				
	SH 20x130	130				

Table C41: Displacement

Effective anchorage depth h_{ef}	N	δ_{N0}	$\delta_{N\infty}$	V	δ_{V0}	$\delta_{V\infty}$
[mm]	[kN]	[mm]	[mm]	[kN]	[mm]	[mm]
80	$\frac{N_{Rk}}{1,4 \cdot \gamma_M}$	0,27	0,54	$\frac{V_{Rk}}{1,4 \cdot \gamma_M}$	1,21	1,81
85		0,39	0,77		2,00	3,01
130		0,16	0,32		1,60	2,39

Apolo MEA Injection System for masonry
ResiFIX PYSF, PYSF Change, PYSF Express, PYSF Tropical

Performance Clay hollow brick BGV Thermo
 Brick description, drawing,
 Installation parameters, Displacements

Annex C 22

Brick type: Clay hollow brick BGV Thermo

Table C42: Characteristic values of resistance under tension and shear loads

Anchor size	Sleeve	Effective anchorage depth	Characteristic resistance		
			Use category		
			d/d	w/d	w/w
			40°C / 24°C	80°C / 50°C	For all temperature range
h_{ef}	$N_{Rk}^{1)}$	$N_{Rk}^{1)}$	$V_{Rk,b}^{2)}$		
[mm]	[kN]				
Compressive strength $f_b \geq 4 \text{ N/mm}^2$					
M8	SH 12x80	80	0,5	0,4	2,0
	SH 16x85	85	0,75	0,5	2,0
	SH 16x130	130	0,9	0,75	2,5
	SH 16x130/330	130	0,9	0,75	2,5
M10	SH 16x85	85	0,75	0,5	2,0
	SH 16x130	130	1,2	0,75	2,5
	SH 16x130/330	130	1,2	0,75	2,5
M12	SH 20x85	85	0,75	0,5	2,0
	SH 20x130	130	1,2	0,75	2,5
M16	SH 20x85	85	0,9	0,6	2,0
	SH 20x130	130	1,2	0,75	2,5
Compressive strength $f_b \geq 6 \text{ N/mm}^2$					
M8	SH 12x80	80	0,6	0,5	2,0
	SH 16x85	85	0,9	0,6	2,5
	SH 16x130	130	1,2	0,9	3,0
	SH 16x130/330	130	1,2	0,9	3,0
M10	SH 16x85	85	0,9	0,6	2,5
	SH 16x130	130	1,5	0,9	3,0
	SH 16x130/330	130	1,5	0,9	3,0
M12	SH 20x85	85	0,9	0,6	3,0
	SH 20x130	130	1,5	0,9	3,0
M16	SH 20x85	85	1,2	0,75	3,0
	SH 20x130	130	1,5	0,9	3,0
Compressive strength $f_b \geq 10 \text{ N/mm}^2$					
M8	SH 12x80	80	0,9	0,6	3,0
	SH 16x85	85	1,2	0,9	3,5
	SH 16x130	130	1,5	1,2	4,0
	SH 16x130/330	130	1,5	1,2	4,0
M10	SH 16x85	85	1,2	0,9	3,5
	SH 16x130	130	1,5	1,2	4,0
	SH 16x130/330	130	1,5	1,2	4,0
M12	SH 20x85	85	1,2	0,75	3,5
	SH 20x130	130	1,5	1,2	4,0
M16	SH 20x85	85	1,5	0,9	3,5
	SH 20x130	130	1,5	1,2	4,0

¹⁾ For design according ETAG 029, Annex C: $N_{Rk} = N_{Rk,p} = N_{Rk,b}$; $N_{Rk,s}$ according to Table C2 Annex C2; Calculation $N_{Rk,pb}$ see ETAG 029, Annex C

²⁾ For $V_{Rk,s}$ see Annex C 2, Table C2; Calculation of $V_{Rk,pb}$ and $V_{Rk,c}$ see ETAG 029, Annex C

Apolo MEA Injection System for masonry
ResiFIX PYSF, PYSF Change, PYSF Express, PYSF Tropical

Performance Clay hollow brick BGV Thermo
 Characteristic values of resistance under tension and shear load

Annex C 23

Brick type: Clay hollow brick Calibric Th

Table C43: Description

Brick type	Clay hollow brick Calibric Th	
Bulk density [kg/dm³]	0,62	
Compressive strength [N/mm²]	6, 9 or 12	
Code	EN 771-1	
Producer (country code)	e.g. Terreal (FR)	
Brick dimensions [mm]	500 x 200 x 314	
Drilling method	Rotary drilling	

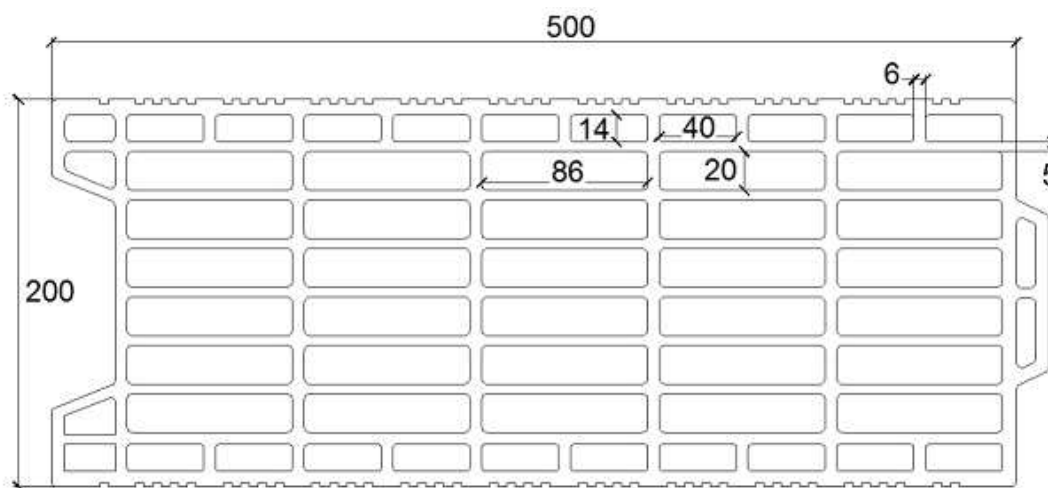

Table C44: Installation parameter (Edge and spacing distances)

Anchor size	Sleeve	Embedment depth	Edge distance	Spacing		Maximum installation torque
		h_{ef}		$C_{min} = C_{Cr}$	$S_{cr} = S_{min II}$	
		[mm]				[Nm]
M8	SH 12x80	80	100	500	314	2
M8 / M10	SH 16x85	85				
	SH 16x130	130				
	SH 16x130/330	130				
M12 / M16	SH 20x85	85	120	500	314	2
	SH 20x130	130				

Table C45: Displacement

Effective anchorage depth h_{ef}	N	δ_{N0}	$\delta_{N\infty}$	V	δ_{V0}	$\delta_{V\infty}$
[mm]	[kN]	[mm]	[mm]	[kN]	[mm]	[mm]
80	$\frac{N_{Rk}}{1,4 \cdot \gamma_M}$	0,48	0,96	$\frac{V_{Rk}}{1,4 \cdot \gamma_M}$	1,18	1,78
85		0,49	0,98		2,20	3,30
130		0,37	0,74		2,31	3,46

Apolo MEA Injection System for masonry
ResiFIX PYSF, PYSF Change, PYSF Express, PYSF Tropical

Performance Clay hollow brick Calibric Th
 Brick description, drawing,
 Installation parameters, Displacements

Annex C 24

Brick type: Clay hollow brick Calibric Th

Table C46: Characteristic values of resistance under tension and shear loads

Anchor size	Sleeve	Effective anchorage depth	Characteristic resistance		
			Use category		
			d/d w/d w/w		
			40°C / 24°C	80°C / 50°C	For all temperature range
h_{ef}	$N_{Rk}^{1)}$	$N_{Rk}^{1)}$	$V_{Rk,b}^{2)}$		
[mm]	[kN]				
Compressive strength $f_b \geq 6 \text{ N/mm}^2$					
M8	SH 12x80	80	0,75	0,5	2,5
	SH 16x85	85	0,75	0,5	3,5
	SH 16x130	130	0,9	0,6	3,5
	SH 16x130/330	130	0,9	0,6	3,5
M10	SH 16x85	85	0,75	0,5	3,5
	SH 16x130	130	0,9	0,6	3,5
	SH 16x130/330	130	0,9	0,6	3,5
M12	SH 20x85	85	0,75	0,5	6,0
	SH 20x130	130	0,9	0,6	6,0
M16	SH 20x85	85	1,2	0,75	6,0
	SH 20x130	130	1,2	0,75	6,0
Compressive strength $f_b \geq 9 \text{ N/mm}^2$					
M8	SH 12x80	80	0,9	0,6	3,5
	SH 16x85	85	0,9	0,6	4,5
	SH 16x130	130	1,2	0,75	4,5
	SH 16x130/330	130	1,2	0,75	4,5
M10	SH 16x85	85	0,9	0,6	4,5
	SH 16x130	130	1,2	0,9	4,5
	SH 16x130/330	130	1,2	0,9	4,5
M12	SH 20x85	85	0,9	0,6	7,5
	SH 20x130	130	1,2	0,9	7,5
M16	SH 20x85	85	1,5	0,9	7,5
	SH 20x130	130	1,5	0,9	7,5
Compressive strength $f_b \geq 12 \text{ N/mm}^2$					
M8	SH 12x80	80	0,9	0,75	4,0
	SH 16x85	85	0,9	0,75	5,5
	SH 16x130	130	1,2	0,9	5,5
	SH 16x130/330	130	1,2	0,9	5,5
M10	SH 16x85	85	0,9	0,75	5,5
	SH 16x130	130	1,5	0,9	5,5
	SH 16x130/330	130	1,5	0,9	5,5
M12	SH 20x85	85	0,9	0,75	8,5
	SH 20x130	130	1,5	0,9	8,5
M16	SH 20x85	85	1,5	1,2	8,5
	SH 20x130	130	1,5	1,2	8,5

¹⁾ For design according ETAG 029, Annex C: $N_{Rk} = N_{Rk,p} = N_{Rk,b}$; $N_{Rk,s}$ according to Table C2 Annex C2; Calculation $N_{Rk,pb}$ see ETAG 029, Annex C

²⁾ For $V_{Rk,s}$ see Annex C 2, Table C2; Calculation of $V_{Rk,pt}$ and $V_{Rk,c}$ see ETAG 029, Annex C

Apolo MEA Injection System for masonry
ResiFIX PYSF, PYSF Change, PYSF Express, PYSF Tropical

Performance Clay hollow brick Calibric Th
 Characteristic values of resistance under tension and shear load

Annex C 25

Brick type: Clay hollow brick Urbanbric

Table C47: Description

Brick type	Clay hollow brick Urbanbric	
Bulk density [kg/dm³]	0,74	
Compressive strength [N/mm²]	6 or 9	
Code	EN 771-1	
Producer (country code)	e.g. Imerys (FR)	
Brick dimensions [mm]	560 x 200 x 274	
Drilling method	Rotary drilling	

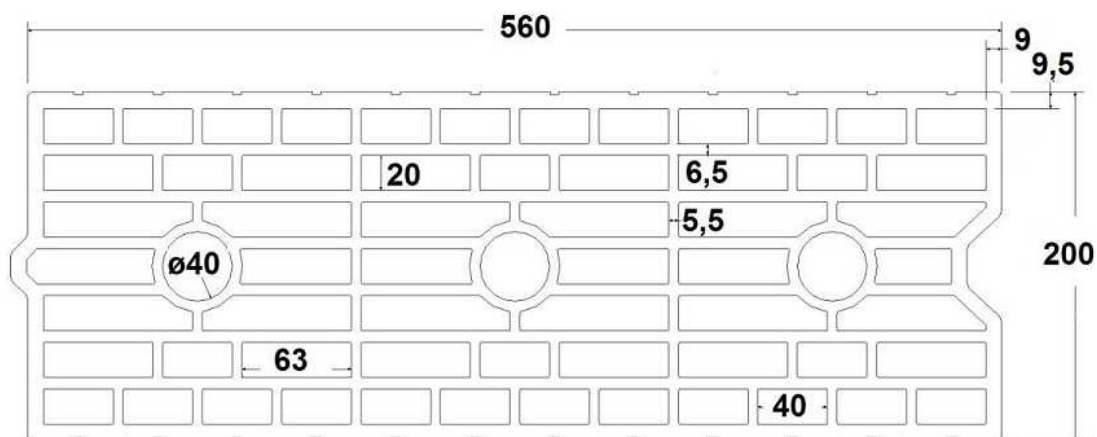

Table C48: Installation parameter (Edge and spacing distances)

Anchor size	Sleeve	Embedment depth	Edge distance	Spacing		Maximum installation torque
		h_{ef}	$c_{min} = c_{cr}$	$s_{cr} = s_{min \parallel}$	$s_{min \perp}$	$T_{inst,max}$
		[mm]				[Nm]
M8	SH 12x80	80	100	560	274	2
M8 / M10	SH 16x85	85				
	SH 16x130 SH 16x130/330	130				
M12 / M16	SH 20x85	85	120	560	274	2
	SH 20x130	130				

Table C49: Displacement

Effective anchorage depth h_{ef}	N	δ_{N0}	$\delta_{N\infty}$	V	δ_{V0}	$\delta_{V\infty}$
[mm]	[kN]	[mm]	[mm]	[kN]	[mm]	[mm]
80	$\frac{N_{Rk}}{1,4 \cdot \gamma_M}$	0,34	0,67	$\frac{V_{Rk}}{1,4 \cdot \gamma_M}$	0,71	1,06
85		0,52	1,04		1,37	2,06
130		0,62	1,24		1,62	2,44

Apolo MEA Injection System for masonry
ResiFIX PYSF, PYSF Change, PYSF Express, PYSF Tropical

Performance Clay hollow brick Calibric Th
 Brick description, drawing,
 Installation parameters, Displacements

Annex C 26

Brick type: Clay hollow brick Urbanbric

Table C50: Characteristic values of resistance under tension and shear loads

Anchor size	Sleeve	Effective anchorage depth	Characteristic resistance		
			Use category		
			d/d w/d w/w		
			40°C / 24°C	80°C / 50°C	For all temperature range
h_{ef} [mm]	$N_{Rk}^{1)}$	$N_{Rk}^{1)}$	$V_{Rk,b}^{2)}$	[kN]	
Compressive strength $f_b \geq 6 \text{ N/mm}^2$					
M8	SH 12x80	80	0,9	0,75	3,0
M8 / M10	SH 16x85	85	1,2	0,75	3,5
	SH 16x130	130	1,5	1,2	3,5
M12 / M16	SH 16x130/330	130	1,5	1,2	3,5
	SH 20x85	85	1,2	0,75	4,0
M12 / M16	SH 20x130	130	1,5	1,2	4,0
	Compressive strength $f_b \geq 9 \text{ N/mm}^2$				
M8	SH 12x80	80	1,2	0,9	3,5
M8 / M10	SH 16x85	85	1,5	0,9	4,0
	SH 16x130	130	2,0	1,5	4,5
	SH 16x130/330	130	2,0	1,5	4,5
M12 / M16	SH 20x85	85	1,5	0,9	5,0
	SH 20x130	130	2,0	1,5	5,0

1) For design according ETAG 029, Annex C: $N_{Rk} = N_{Rk,p} = N_{Rk,b}$; $N_{Rk,s}$ according to Table C2 Annex C2; Calculation $N_{Rk,pb}$ see ETAG 029, Annex C

2) For $V_{Rk,s}$ see Annex C 2, Table C2; Calculation of $V_{Rk,pb}$ and $V_{Rk,c}$ see ETAG 029, Annex C

Apolo MEA Injection System for masonry
ResiFIX PYSF, PYSF Change, PYSF Express, PYSF Tropical

Performance Clay hollow brick Calibric Th
 Characteristic values of resistance under tension and shear load

Annex C 27

Brick type: Clay hollow brick Blocchi Leggeri

Table C51: Description

Brick type	Clay hollow brick Blocchi Leggeri	
Bulk density [kg/dm ³]	0,55	
Compressive strength [N/mm ²]	4, 6 or 8	
Code	EN 771-1	
Producer (country code)	e.g. Wienerberger (IT)	
Brick dimensions [mm]	250 x 120 x 250	
Drilling method	Rotary drilling	

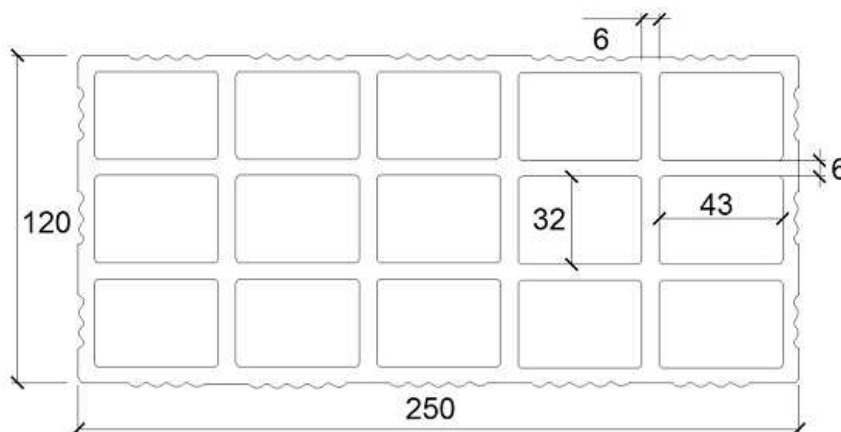

Table C52: Installation parameter (Edge and spacing distances)

Anchor size	Sleeve	Embedment depth	Edge distance	Spacing		Maximum installation torque
				$S_{cr} = S_{min \parallel}$	$S_{min \perp}$	
		h_{ef}	$C_{min} = C_{cr}$	[mm]		$T_{inst,max}$
						[Nm]
M8	SH 12x80	80	100	250	250	4
M8 / M10	SH 16x85	85				
	SH 16x130	130				
	SH 16x130/330	130				
M12 / M16	SH 20x85	85	120	250	250	4
	SH 20x130	130				
	SH 20x200	200				

Table C53: Displacement

Effective anchorage depth h_{ef}	N	δ_{N0}	$\delta_{N\infty}$	V	δ_{V0}	$\delta_{V\infty}$
[mm]	[kN]	[mm]	[mm]	[kN]	[mm]	[mm]
80	$\frac{N_{Rk}}{1,4 \cdot \gamma_M}$	0,32	0,64	$\frac{V_{Rk}}{1,4 \cdot \gamma_M}$	1,16	1,74
85		0,26	0,53		2,52	3,78
130 ; 200		0,32	0,64		2,52	3,78

Apolo MEA Injection System for masonry
ResiFIX PYSF, PYSF Change, PYSF Express, PYSF Tropical

Performance Clay hollow brick Blocchi Leggeri
 Brick description, drawing,
 Installation parameters, Displacements

Annex C 28

Brick type: Clay hollow brick Blocchi Leggeri

Table C54: Characteristic values of resistance under tension and shear loads

Anchor size	Sleeve	Effective anchorage depth	Characteristic resistance		
			Use category		
			d/d w/d w/w		
			40°C / 24°C	80°C / 50°C	For all temperature range
h_{ef}	$N_{Rk}^{1)}$	$N_{Rk}^{1)}$	$V_{Rk,b}^{2)}$		
		[mm]	[kN]		
Compressive strength $f_b \geq 4 \text{ N/mm}^2$					
M8	SH 12x80	80	0,4	0,3	2,0
M8 / M10	SH 16x85	85	0,4	0,3	2,0
	SH 16x130	130	0,5	0,3	2,0
	SH 16x130/330	130	0,5	0,3	2,0
M12 / M16	SH 20x85	85	0,4	0,3	2,0
	SH 20x130	130	0,5	0,3	2,0
	SH 20x200	200	0,5	0,3	2,0
Compressive strength $f_b \geq 6 \text{ N/mm}^2$					
M8	SH 12x80	80	0,5	0,3	2,0
M8 / M10	SH 16x85	85	0,5	0,3	2,0
	SH 16x130	130	0,6	0,4	2,0
	SH 16x130/330	130	0,6	0,4	2,0
M12 / M16	SH 20x85	85	0,5	0,3	2,5
	SH 20x130	130	0,6	0,4	2,5
	SH 20x200	200	0,6	0,4	2,5
Compressive strength $f_b \geq 8 \text{ N/mm}^2$					
M8	SH 12x80	80	0,6	0,4	2,5
M8 / M10	SH 16x85	85	0,6	0,4	2,5
	SH 16x130	130	0,6	0,5	2,5
	SH 16x130/330	130	0,6	0,5	2,5
M12 / M16	SH 20x85	85	0,6	0,4	3,0
	SH 20x130	130	0,6	0,5	3,0
	SH 20x200	200	0,6	0,5	3,0

¹⁾ For design according ETAG 029, Annex C: $N_{Rk} = N_{Rk,p} = N_{Rk,b}$; $N_{Rk,s}$ according to Table C2 Annex C2; Calculation $N_{Rk,pb}$ see ETAG 029, Annex C

²⁾ For $V_{Rk,s}$ see Annex C 2, Table C2; Calculation of $V_{Rk,pt}$ and $V_{Rk,c}$ see ETAG 029, Annex C

Apolo MEA Injection System for masonry ResiFIX PYSF, PYSF Change, PYSF Express, PYSF Tropical	Annex C 29
Performance Clay hollow brick Blocchi Leggeri Characteristic values of resistance under tension and shear load	

Brick type: Clay hollow brick Doppio Uni

Table C55: Description

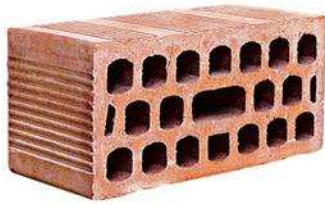
Brick type	Clay hollow brick Doppio Uni	
Bulk density [kg/dm³]	0,92	
Compressive strength [N/mm²]	10, 16, 20 or 28	
Code	EN 771-1	
Producer (country code)	e.g. Wienerberger (IT)	
Brick dimensions [mm]	250 x 120 x 120	
Drilling method	Rotary drilling	

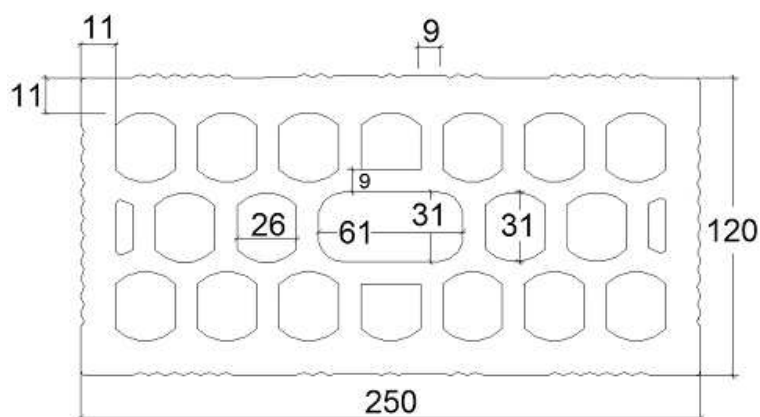

Table C56: Installation parameter (Edge and spacing distances)

Anchor size	Sleeve	Embedment depth	Edge distance	Spacing		Maximum installation torque
		h_{ef}	$C_{min} = C_{cr}$	$S_{cr} = S_{min \parallel}$	$S_{min \perp}$	
				[mm]		$T_{inst,max}$
						[Nm]
M8	SH 12x80	80	100	250	120	4
M8 / M10	SH 16x85	85				
	SH 16x130	130				
	SH 16x130/330	130				
M12 / M16	SH 20x85	85	120	250	120	4
	SH 20x130	130				
	SH 20x200	200				

Table C57: Displacement

Effective anchorage depth h_{ef}	N	δ_{N0}	$\delta_{N\infty}$	V	δ_{V0}	$\delta_{V\infty}$
[mm]	[kN]	[mm]	[mm]	[kN]	[mm]	[mm]
80	$\frac{N_{Rk}}{1,4 \cdot \gamma_M}$	0,54	1,08	$\frac{V_{Rk}}{1,4 \cdot \gamma_M}$	1,63	2,45
85		0,17	0,34		1,75	2,63
130 ; 200		0,54	1,08		1,75	2,63

Apolo MEA Injection System for masonry
ResiFIX PYSF, PYSF Change, PYSF Express, PYSF Tropical

Performance Clay hollow brick Doppio Uni
 Brick description, drawing,
 Installation parameters, Displacements

Annex C 30

Brick type: Clay hollow brick Doppio Uni

Table C58: Characteristic values of resistance under tension and shear loads

Anchor size	Sleeve	Effective anchorage depth	Characteristic resistance		
			Use category		
			d/d w/d w/w		
			40°C / 24°C	80°C / 50°C	For all temperature range
h_{ef} [mm]	$N_{Rk}^{1)}$	$N_{Rk}^{1)}$	$V_{Rk,b}^{2)}$		
[kN]					
Compressive strength $f_b \geq 10 \text{ N/mm}^2$					
M8	SH 12x80	80	0,9	0,6	2,0
M8 / M10	SH 16x85	85	0,9	0,6	2,0
	SH 16x130	130	0,9	0,6	2,0
	SH 16x130/330	130	0,9	0,6	2,0
M12 / M16	SH 20x85	85	1,2	0,75	2,0
	SH 20x130	130	1,2	0,75	2,0
	SH 20x200	200	1,2	0,75	2,0
Compressive strength $f_b \geq 16 \text{ N/mm}^2$					
M8	SH 12x80	80	0,9	0,75	2,5
M8 / M10	SH 16x85	85	1,2	0,9	2,5
	SH 16x130	130	1,2	0,9	2,5
	SH 16x130/330	130	1,2	0,9	2,5
M12 / M16	SH 20x85	85	1,5	0,9	2,5
	SH 20x130	130	1,5	0,9	2,5
	SH 20x200	200	1,5	0,9	2,5
Compressive strength $f_b \geq 20 \text{ N/mm}^2$					
M8	SH 12x80	80	1,2	0,75	3,0
M8 / M10	SH 16x85	85	1,2	0,9	3,0
	SH 16x130	130	1,5	0,9	3,0
	SH 16x130/330	130	1,5	0,9	3,0
M12 / M16	SH 20x85	85	1,5	0,9	3,0
	SH 20x130	130	1,5	0,9	3,0
	SH 20x200	200	1,5	0,9	3,0
Compressive strength $f_b \geq 28 \text{ N/mm}^2$					
M8	SH 12x80	80	1,5	0,9	3,5
M8 / M10	SH 16x85	85	1,5	1,2	3,5
	SH 16x130	130	1,5	1,2	3,5
	SH 16x130/330	130	1,5	1,2	3,5
M12 / M16	SH 20x85	85	2,0	1,2	3,5
	SH 20x130	130	2,0	1,2	3,5
	SH 20x200	200	2,0	1,2	3,5

¹⁾ For design according ETAG 029, Annex C: $N_{Rk} = N_{Rk,p} = N_{Rk,b}$; $N_{Rk,s}$ according to Table C2 Annex C2; Calculation $N_{Rk,pb}$ see ETAG 029, Annex C

²⁾ For $V_{Rk,s}$ see Annex C 2, Table C2; Calculation of $V_{Rk,pb}$ and $V_{Rk,c}$ see ETAG 029, Annex C

Apolo MEA Injection System for masonry
ResiFIX PYSF, PYSF Change, PYSF Express, PYSF Tropical

Performance Clay hollow brick Doppio Uni
 Characteristic values of resistance under tension and shear load

Annex C 31

Brick type: Hollow Light weight concrete Bloc creux B40

Table C59: Description

Brick type	Hollow light weight concrete Bloc creux B40	
Bulk density [kg/dm³]	0,8	
Compressive strength [N/mm²]	4	
Code	EN 771-3	
Producer (country code)	e.g. Sepa (FR)	
Brick dimensions [mm]	494 x 200 x 190	
Drilling method	Rotary drilling	

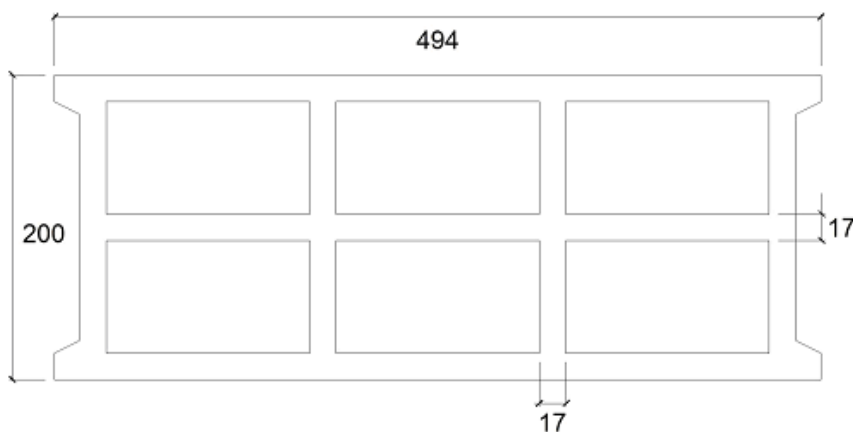

Table C60: Installation parameter (Edge and spacing distances)

Anchor size	Sleeve	Embedment depth	Edge distance	Spacing		Maximum installation torque			
				h_{ef}	$c_{min} = c_{cr}$		$s_{cr} = s_{min \parallel}$	$s_{min \perp}$	$T_{inst,max}$
				[mm]				[Nm]	
M8	SH 12x80	80	100	494	190	2			
M8 / M10	SH 16x85	85							
	SH 16x130	130							
	SH 16x130/330	130							
M12 / M16	SH 20x85	85	120	494	190	2			
	SH 20x130	130							

Table C61: Displacement

Effective anchorage depth h_{ef}	N	δ_{N0}	$\delta_{N\infty}$	V	δ_{V0}	$\delta_{V\infty}$
[mm]	[kN]	[mm]	[mm]	[kN]	[mm]	[mm]
80	$\frac{N_{Rk}}{1,4 \cdot \gamma_M}$	0,14	0,29	$\frac{V_{Rk}}{1,4 \cdot \gamma_M}$	0,25	0,37
85		0,45	0,90		0,98	1,47
130		0,61	1,22		1,10	1,65

**Apolo MEA Injection System for masonry
ResiFIX PYSF, PYSF Change, PYSF Express, PYSF Tropical**

Performance hollow light weight concrete Bloc creux B40
Brick description, drawing,
Installation parameters, Displacements

Annex C 32

Brick type: Hollow Light weight concrete Bloc creux B40

Table C62: Characteristic values of resistance under tension and shear loads

Anchor size	Sleeve	Effective anchorage depth	Characteristic resistance		
			Use category		
			d/d w/d w/w		
			40°C / 24°C	80°C / 50°C	For all temperature range
h_{ef}	$N_{Rk}^{1)}$	$N_{Rk}^{1)}$	$V_{Rk,b}^{2)}$		
[mm]	[kN]				
Compressive strength $f_b \geq 4 \text{ N/mm}^2$					
M8	SH 12x80	80	0,4	0,3	1,2
	SH 16x85	85	0,6	0,5	3,0
	SH 16x130	130	2,0	1,5	3,5
	SH 16x130/330	130	2,0	1,5	3,5
M10	SH 16x85	85	0,6	0,5	3,0
	SH 16x130	130	2,0	1,5	3,5
	SH 16x130/330	130	2,0	1,5	3,5
M12	SH 20x85	85	0,9	0,6	3,0
	SH 20x130	130	2,0	1,5	3,5
M16	SH 20x85	85	0,9	0,6	3,0
	SH 20x130	130	2,0	1,5	3,5

¹⁾ For design according ETAG 029, Annex C: $N_{Rk} = N_{Rk,p} = N_{Rk,b}$; $N_{Rk,s}$ according to Table C2 Annex C2; Calculation $N_{Rk,pb}$ see ETAG 029, Annex C

²⁾ For $V_{Rk,s}$ see Annex C 2, Table C2; Calculation of $V_{Rk,pt}$ and $V_{Rk,c}$ see ETAG 029, Annex C

**Apolo MEA Injection System for masonry
ResiFIX PYSF, PYSF Change, PYSF Express, PYSF Tropical**

Performance hollow light weight concrete Bloc creux B40
Characteristic values of resistance under tension and shear load

Annex C 33

Brick type: Solid light weight concrete brick

Table C63: Description

Brick type	Solid light weight concrete brick	
Bulk density [kg/dm ³]	0,63	
Compressive strength [N/mm ²]	2	
Code	EN 771-3	
Producer (country code)	e.g. Bisotherm (DE)	
Brick dimensions [mm]	300 x 123 x 248	
Drilling method	Rotary drilling	

Table C64: Installation parameter (Edge and spacing distances)

Anchor size	Sleeve	Embedment depth	Edge distance	Spacing	Maximum installation torque
		h_{ef}	$C_{min} = C_{cr}$	$S_{cr} = S_{min \parallel} = S_{min \perp}$	$T_{inst,max}$
			[mm]		[Nm]
M8	-	80	120	240	6
M10	-	90	135	270	
M12	-	100	150	300	10
M16	-	100	150	300	14

Table C65: Displacement

Effective anchorage depth h_{ef}	N	δ_{N0}	$\delta_{N\infty}$	V	δ_{V0}	$\delta_{V\infty}$
[mm]	[kN]	[mm]	[mm]	[kN]	[mm]	[mm]
80	$\frac{N_{Rk}}{1,4 \cdot \gamma_M}$	0,64	1,28	$\frac{V_{Rk}}{1,4 \cdot \gamma_M}$	0,50	0,75
90		0,70	1,41		0,68	1,03
100		0,21	0,42		0,54	0,81

**Apolo MEA Injection System for masonry
ResiFIX PYSF, PYSF Change, PYSF Express, PYSF Tropical**

Performance Solid light weight concrete LAC
Brick description, drawing,
Installation parameters, Displacements

Annex C 34

Brick type: Solid light weight concrete brick

Table C66: Characteristic values of resistance under tension and shear loads

Anchor size	Sleeve	Effective anchorage depth	Characteristic resistance		
			Use category		
			d/d w/d w/w		
			40°C / 24°C	80°C / 50°C	For all temperature range
h_{ef}	$N_{Rk}^{1)}$	$N_{Rk}^{1)}$	$V_{Rk,b}^{2)}$		
[mm]	[kN]				
Compressive strength $f_b \geq 2 \text{ N/mm}^2$					
M8	-	80	2,0	1,5	3,0
M10	-	90	2,0	1,5	3,5
M12	-	100	2,0	1,5	4,0
M16	-	100	2,0	1,5	4,0

¹⁾ For design according ETAG 029, Annex C: $N_{Rk} = N_{Rk,p} = N_{Rk,b}$; $N_{Rk,s}$ according to Table C2 Annex C2; Calculation $N_{Rk,pb}$ see ETAG 029, Annex C

²⁾ For $V_{Rk,s}$ see Annex C 2, Table C2; Calculation of $V_{Rk,pt}$ and $V_{Rk,c}$ see ETAG 029, Annex C

**Apolo MEA Injection System for masonry
ResiFIX PYSF, PYSF Change, PYSF Express, PYSF Tropical**

Performance Solid light weight concrete LAC
Characteristic values of resistance under tension and shear load

Annex C 35

Brick type: Hollow light weight concrete brick – Leca Lex harkko RUH-200

Table C67: Description

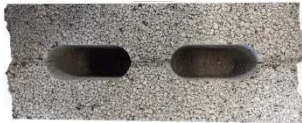
Brick type	Hollow light weight concrete Leca Lex harkko RUH-200	
Bulk density [kg/dm³]	0,7	
Compressive strength [N/mm²]	2,7	
Code	EN 771-3	
Producer (country code)	e.g. Saint-Gobain Weber (Fin)	
Brick dimensions [mm]	498 x 200 x 195	
Drilling method	Rotary drilling	

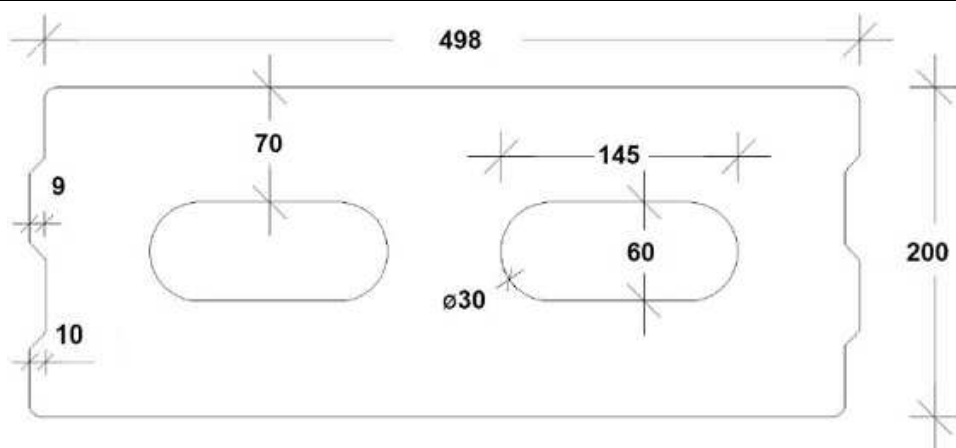

Table C68: Installation parameter (Edge and spacing distances)

Anchor size	Sleeve	Embedment depth	Edge distance	Spacing		Maximum installation torque
				$S_{cr} = S_{min \parallel}$	$S_{min \perp}$	
		h_{ef}	$C_{min} = C_{cr}$	[mm]		$T_{inst,max}$
						[Nm]
M8	SH 12x80	80	120	498	195	8
M8 / M10	SH 16x85	85	127			
	SH 16x130	130	195			
	SH 16x130/330	130	195			
M12 / M16	SH 20x85	85	127			
	SH 20x130	130	195			

Table C69: Displacement

Effective anchorage depth h_{ef}	N	δ_{N0}	$\delta_{N\infty}$	V	δ_{V0}	$\delta_{V\infty}$
[mm]	[kN]	[mm]	[mm]	[kN]	[mm]	[mm]
80	$\frac{N_{Rk}}{1,4 \cdot \gamma_M}$	0,11	0,22	$\frac{V_{Rk}}{1,4 \cdot \gamma_M}$	0,47	0,70
85		0,11	0,23		0,38	0,57
130		0,10	0,20		0,56	0,85

Apolo MEA Injection System for masonry
ResiFIX PYSF, PYSF Change, PYSF Express, PYSF Tropical

Performance LECA LEX harkko RUH-200 Hollow
 Brick description, drawing,
 Installation parameters, Displacements

Annex C 36

Brick type: Hollow light weight concrete brick – Leca Lex harkko RUH-200

Table C70: Characteristic values of resistance under tension and shear loads

Anchor size	Sleeve	Effective anchorage depth	Characteristic resistance		
			Use category		
			d/d w/d w/w		
			40°C / 24°C	80°C / 50°C	For all temperature range
h_{ef}	$N_{Rk}^{1)}$	$N_{Rk}^{1)}$	$V_{Rk,b}^{2)}$		
[mm]	[kN]				
Compressive strength $f_b \geq 2,7 \text{ N/mm}^2$					
M8	SH 12x80	80	2,0	1,2	2,5
	SH 16x85	85	2,0	1,2	3,5
	SH 16x130	130	2,5	1,5	3,5
	SH 16x130/330	130	2,5	1,5	3,5
M10	SH 16x85	85	2,0	1,5	3,5
	SH 16x130	130	2,5	1,5	3,5
	SH 16x130/330	130	2,5	1,5	3,5
M12	SH 20x85	85	2,5	1,5	3,5
	SH 20x130	130	2,5	1,5	3,5
M16	SH 20x85	85	2,5	1,5	3,5
	SH 20x130	130	2,5	1,5	3,5

¹⁾ For design according ETAG 029, Annex C: $N_{Rk} = N_{Rk,p} = N_{Rk,b}$; $N_{Rk,s}$ according to Table C2 Annex C2; Calculation $N_{Rk,pb}$ see ETAG 029, Annex C

²⁾ For $V_{Rk,s}$ see Annex C 2, Table C2; Calculation of $V_{Rk,pt}$ and $V_{Rk,c}$ see ETAG 029, Annex C

Apolo MEA Injection System for masonry
ResiFIX PYSF, PYSF Change, PYSF Express, PYSF Tropical

Performance LECA LEX harkko RUH-200 Hollow
 Characteristic values of resistance under tension and shear load
 Displacement

Annex C 37

Brick type: Solid light weight concrete brick – Leca Lex harkko RUH-200 kulma

Table C71: Description

Brick type	Solid light weight concrete Leca Lex harkko RUH-200 kulma	
Bulk density [kg/dm ³]	0,78	
Compressive strength [N/mm ²]	3	
Code	EN 771-3	
Producer (country code)	e.g. Saint-Gobain Weber (Fin)	
Brick dimensions [mm]	498 x 200 x 195	
Drilling method	Rotary drilling	

Table C72: Installation parameter (Edge and spacing distances)

Anchor size	Sleeve	Embedment depth	Edge distance	Spacing	Maximum installation torque
		h_{ef}	$C_{min} = C_{cr}$	$S_{cr} = S_{min II} = S_{min \perp}$	$T_{inst,max}$
			[mm]		[Nm]
M8	-	80	120	240	6
M10	-	90	135	270	12
M12	-	100	150	300	14
M16	-	100	150	300	16
M8	SH 12x80	80	120	240	8
M8 / M10	SH 16x85	85	127	255	
	SH 16x130	130	195	390	
	SH 16x130/330	130	195	390	
M12 / M16	SH 20x85	85	127	255	12
	SH 20x130	130	195	390	16

Table C73: Displacement

Effective anchorage depth h_{ef}	N	δ_{N0}	$\delta_{N\infty}$	V	δ_{V0}	$\delta_{V\infty}$
[mm]	[kN]	[mm]	[mm]	[kN]	[mm]	[mm]
80	$\frac{N_{Rk}}{1,4 \cdot \gamma_M}$	0,09	0,18	$\frac{V_{Rk}}{1,4 \cdot \gamma_M}$	0,48	0,72
85		0,07	0,15		0,77	1,15
90		0,13	0,26		0,26	0,39
100		0,13	0,23		0,36	0,54
130		0,10	0,21		0,68	1,01

**Apolo MEA Injection System for masonry
ResiFIX PYSF, PYSF Change, PYSF Express, PYSF Tropical**

Performance LECA LEX harkko RUH-200 Kulma Solid
Brick description, drawing,
Installation parameters, Displacements

Annex C 38

Brick type: Solid light weight concrete brick – Leca Lex harkko RUH-200 kulma

Table C74: Characteristic values of resistance under tension and shear loads

Anchor size	Sleeve	Effective anchorage depth	Characteristic resistance		
			Use category		
			d/d	w/d	w/w
			40°C / 24°C	80°C / 50°C	For all temperature range
h_{ef}	$N_{Rk}^{1)}$	$N_{Rk}^{1)}$	$V_{Rk,b}^{2)}$		
[mm]	[kN]				
Compressive strength $f_b \geq 3,0 \text{ N/mm}^2$					
M8	-	80	2,0	1,2	3,0
M10	-	90	3,0	2,0	4,0
M12	-	100	3,0	2,0	4,0
M16	-	100	3,0	2,0	4,0
M8	SH 12x80	80	2,0	1,2	3,0
	SH 16x85	85	2,0	1,5	3,5
	SH 16x130	130	3,0	2,0	4,0
	SH 16x130/330	130	3,0	2,0	4,0
M10	SH 16x85	85	2,0	1,5	3,5
	SH 16x130	130	3,0	2,0	4,0
	SH 16x130/330	130	3,0	2,0	4,0
M12 / M16	SH 20x85	85	2,0	1,5	4,5
	SH 20x130	130	3,0	2,0	4,5

¹⁾ For design according ETAG 029, Annex C: $N_{Rk} = N_{Rk,p} = N_{Rk,b}$; $N_{Rk,s}$ according to Table C2 Annex C2; Calculation $N_{Rk,pb}$ see ETAG 029, Annex C

²⁾ For $V_{Rk,s}$ see Annex C 2, Table C2; Calculation of $V_{Rk,pb}$ and $V_{Rk,c}$ see ETAG 029, Annex C

Apolo MEA Injection System for masonry
ResiFIX PYSF, PYSF Change, PYSF Express, PYSF Tropical

Performance LECA LEX harkko RUH-200 Kulma Solid
 Characteristic values of resistance under tension and shear load

Annex C 39